

G100, G112

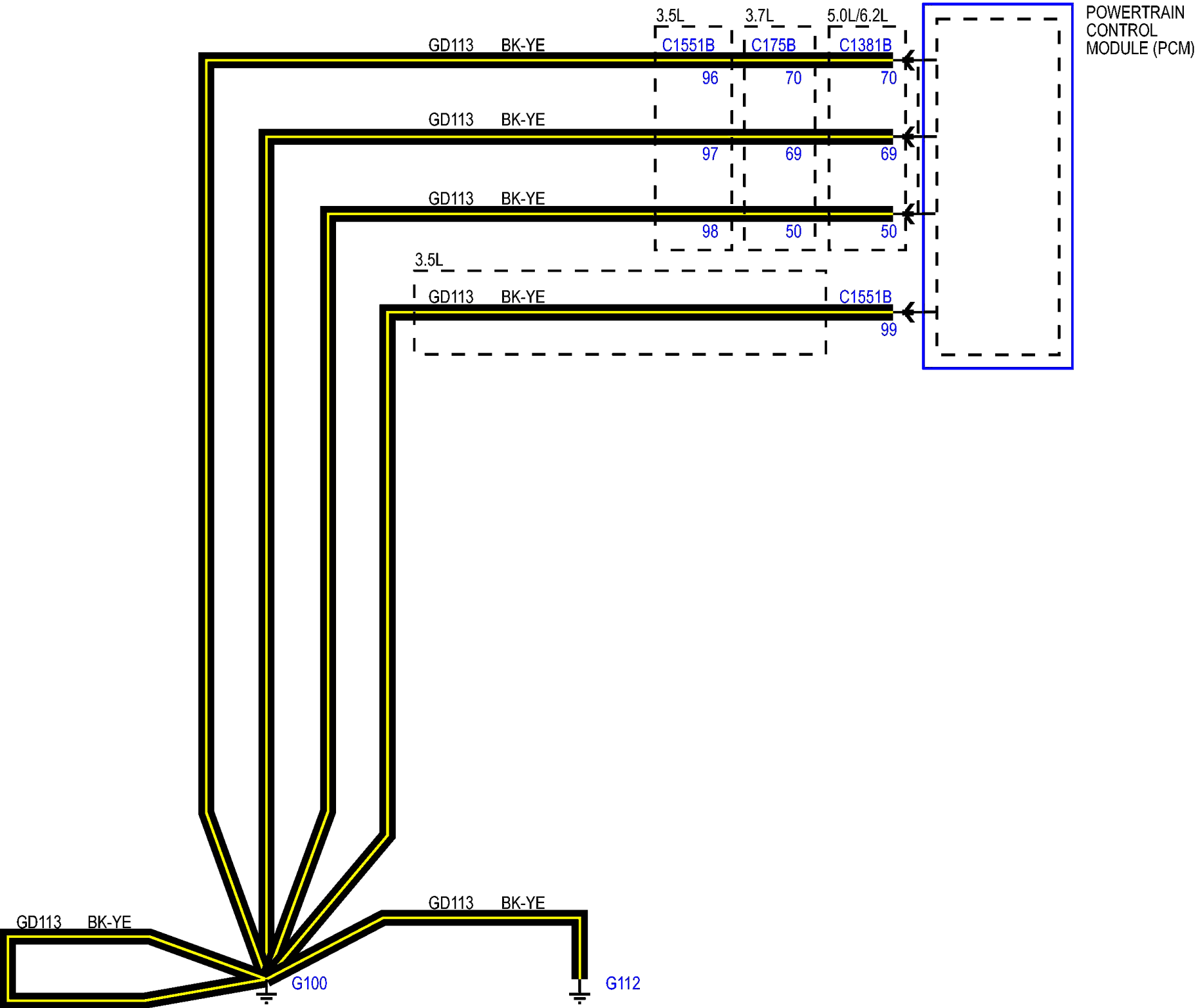

G101

A/C COMPRESSOR
CLUTCH FIELD COIL



HORN

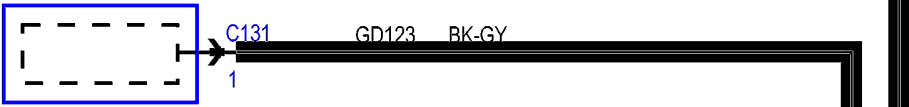

with electronically locking differential

ELECTRONIC LOCKING
DIFFERENTIAL (ELD)
FIELD COIL

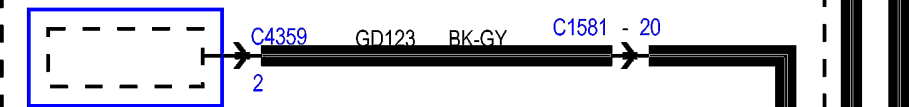

TRANSFER CASE
CONTROL MODULE
(TCM)

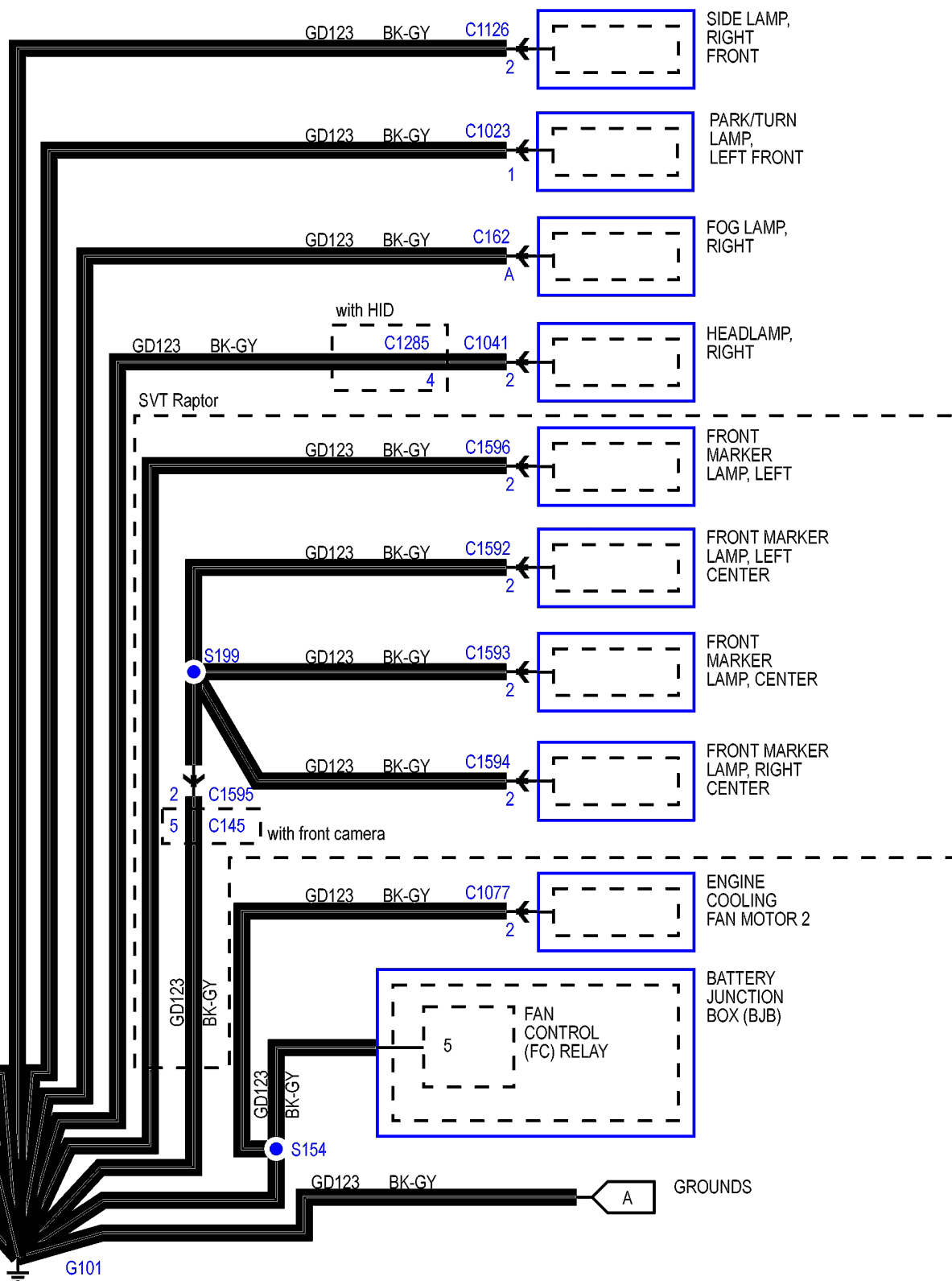
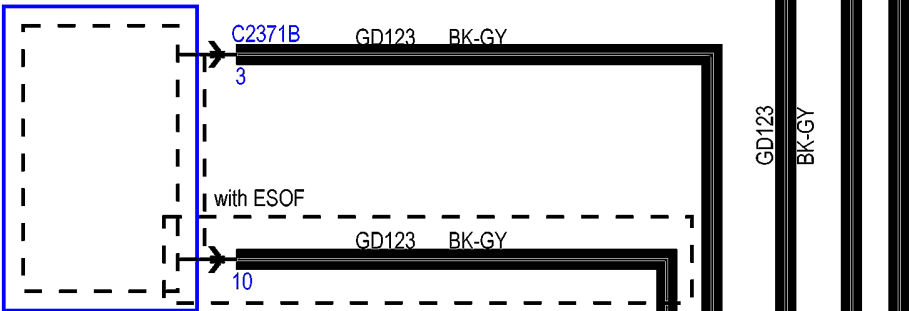

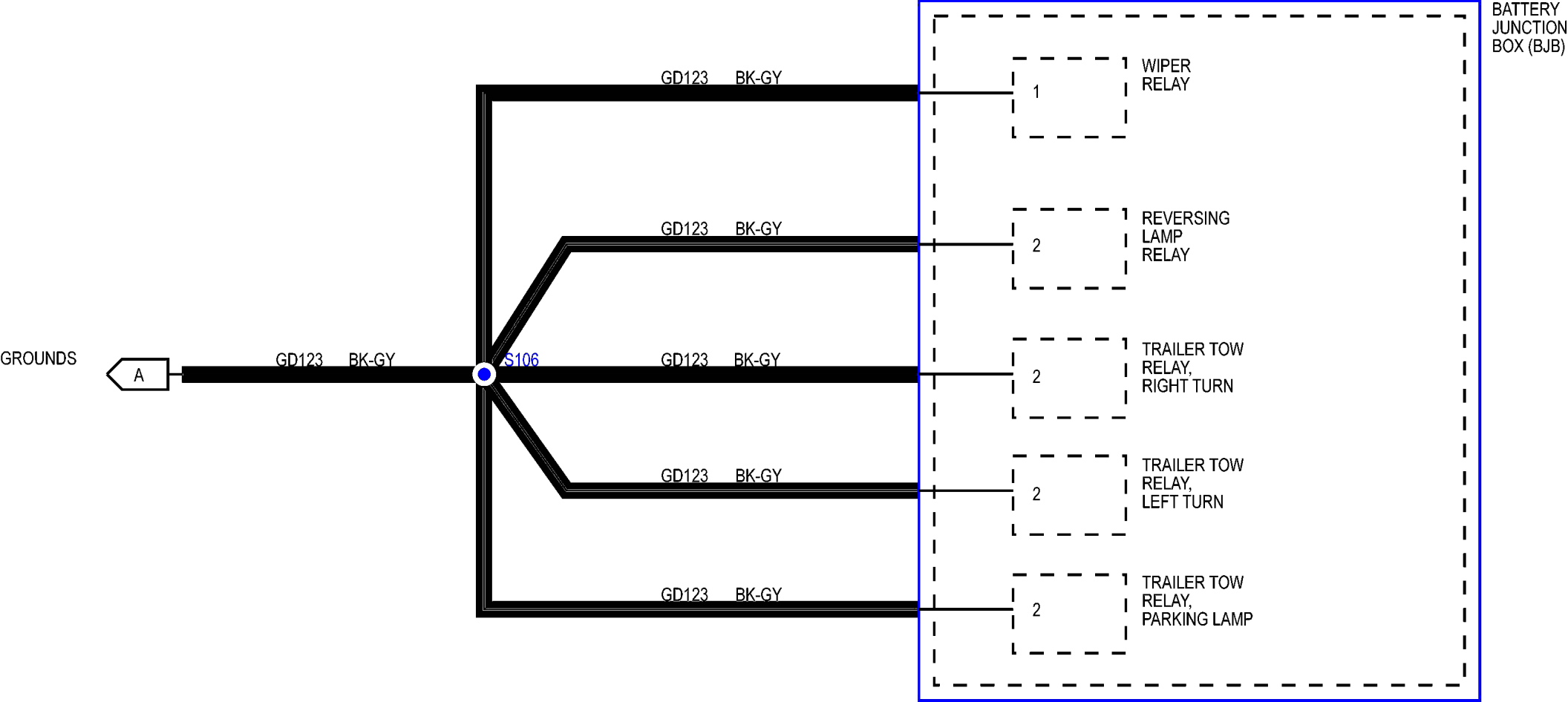

BATTERY
JUNCTION
BOX (BJB)

G102

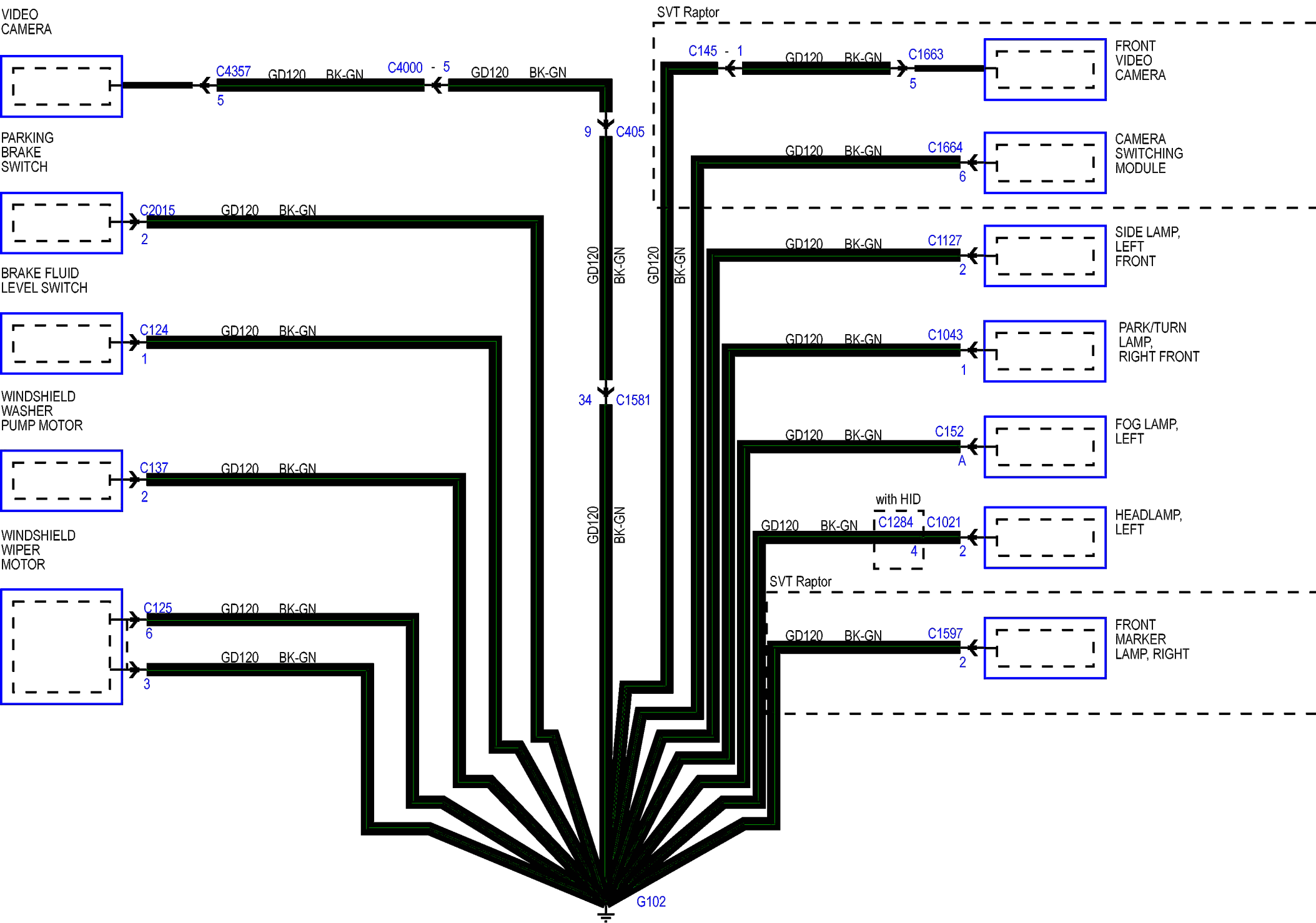

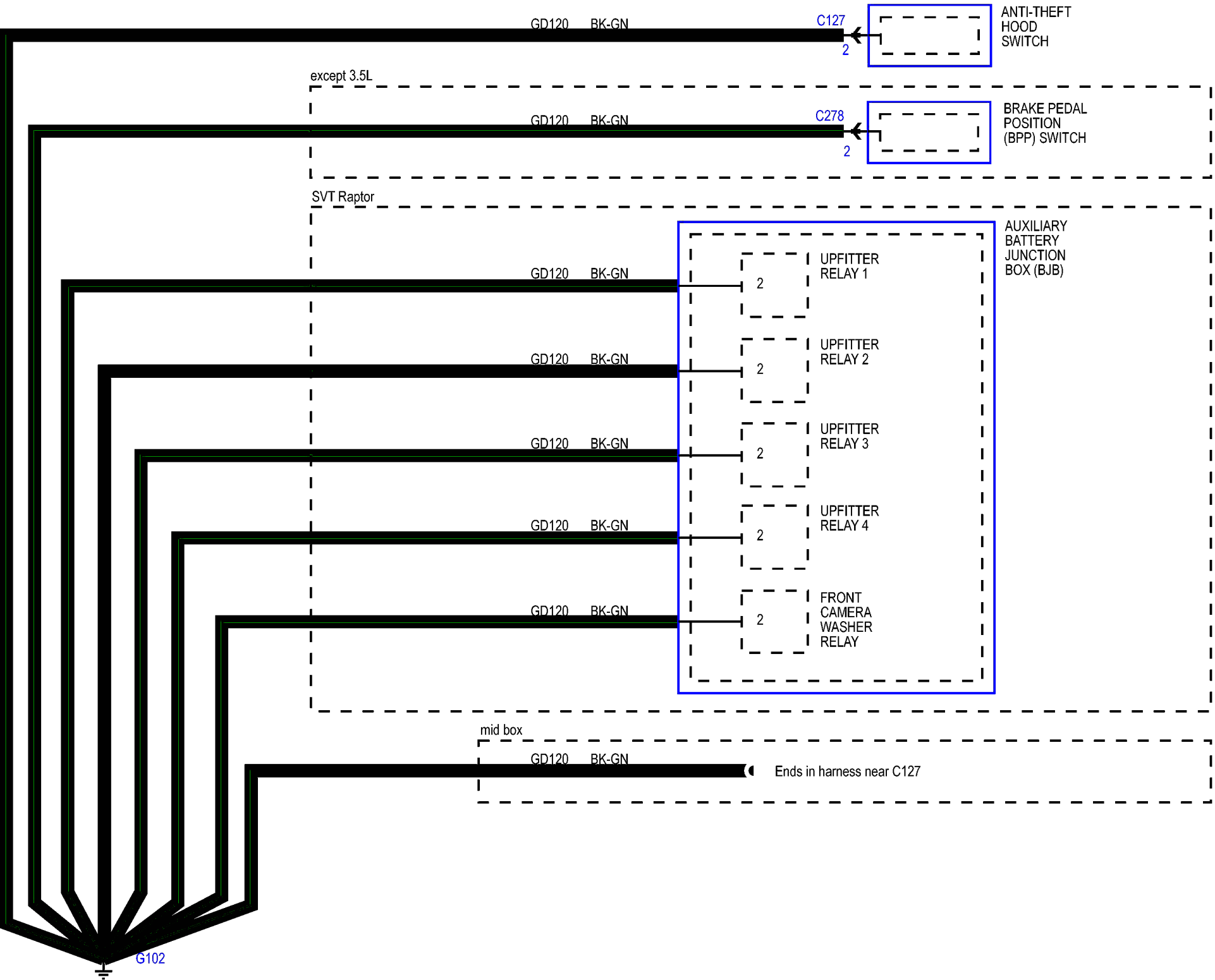

G103, G104, G105, G106, G107, G108, G109, G110, G111

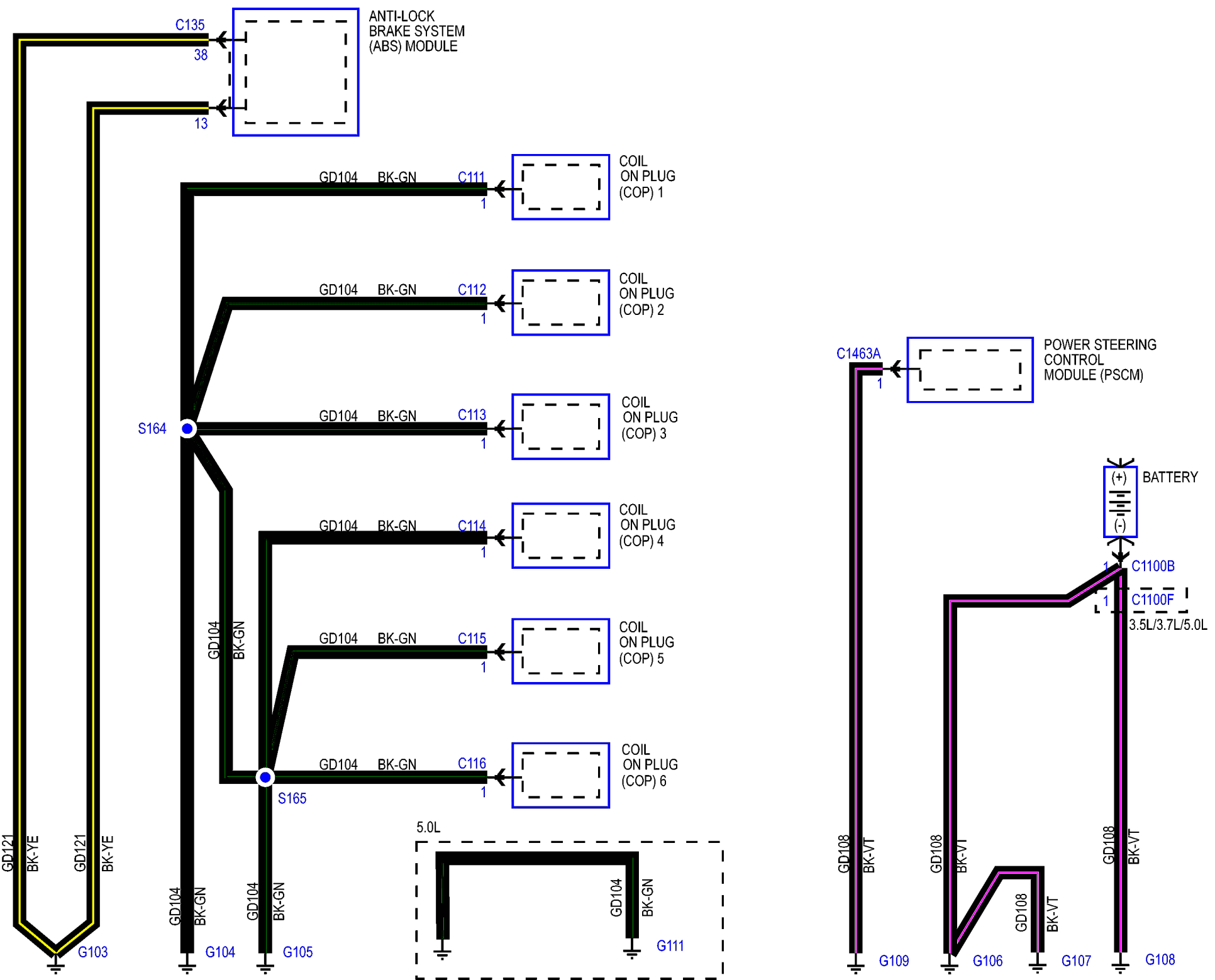

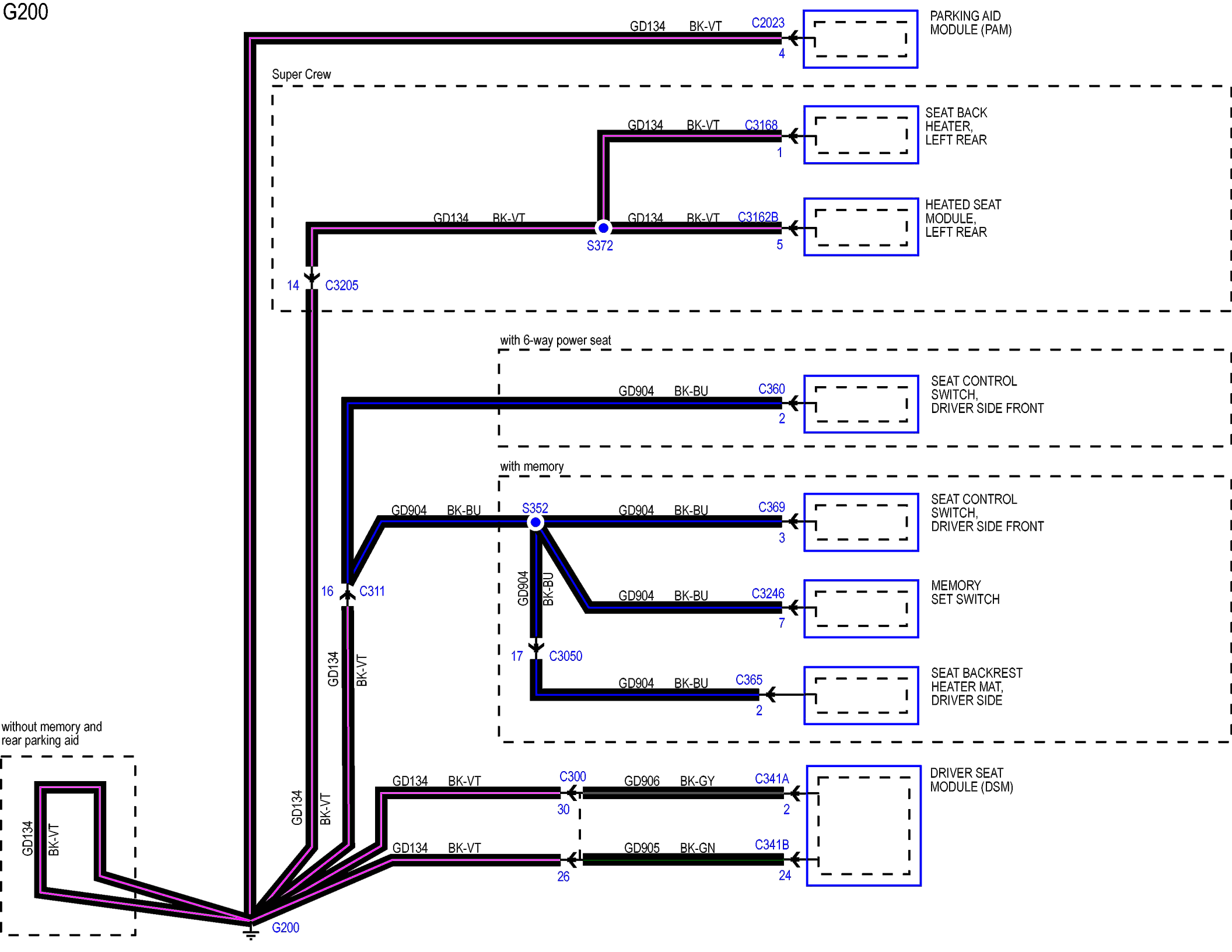

G200

with power equipment

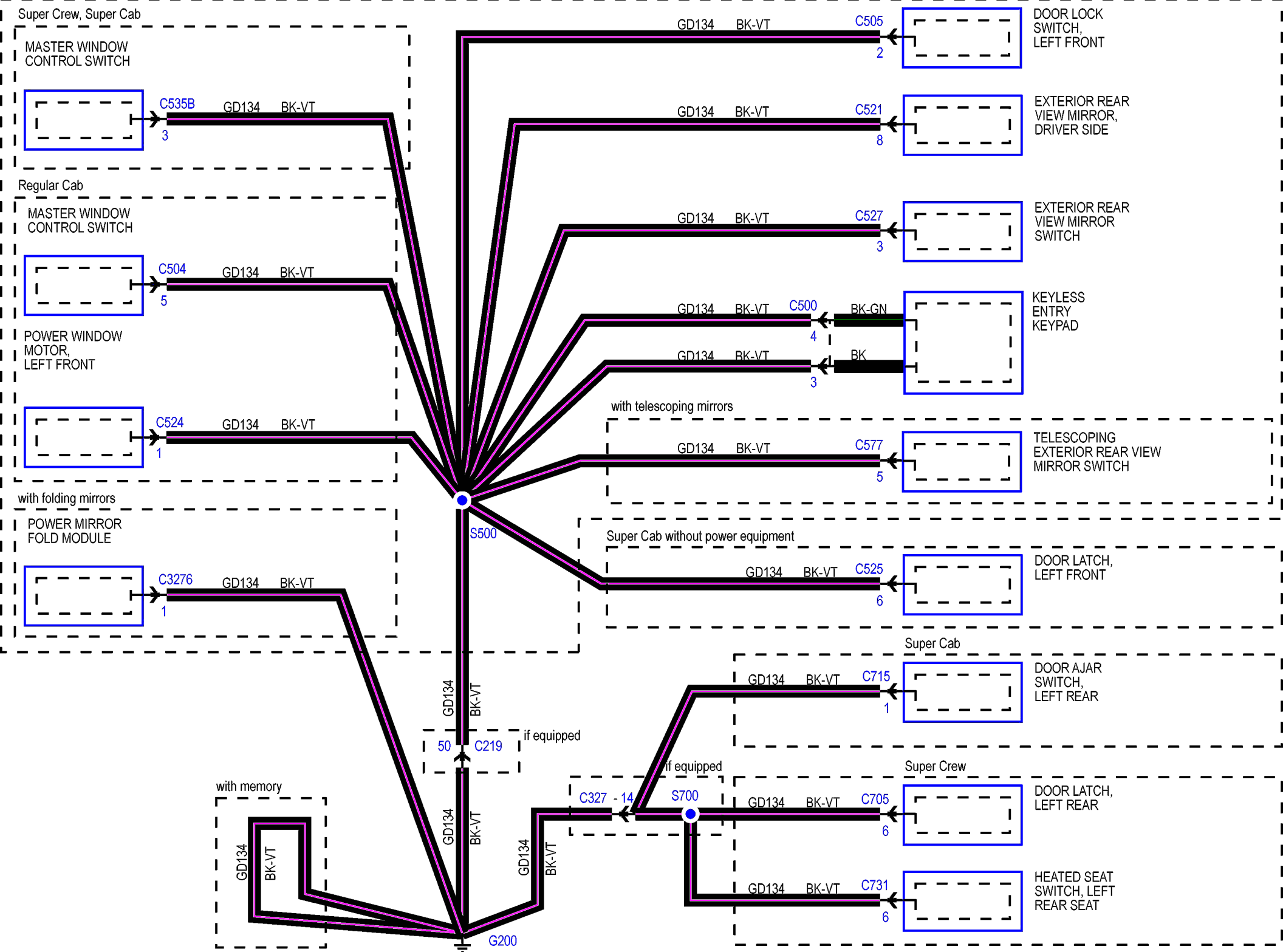

G201

HIGH MOUNTED
STOPLAMP

BODY
CONTROL
MODULE (BCM)

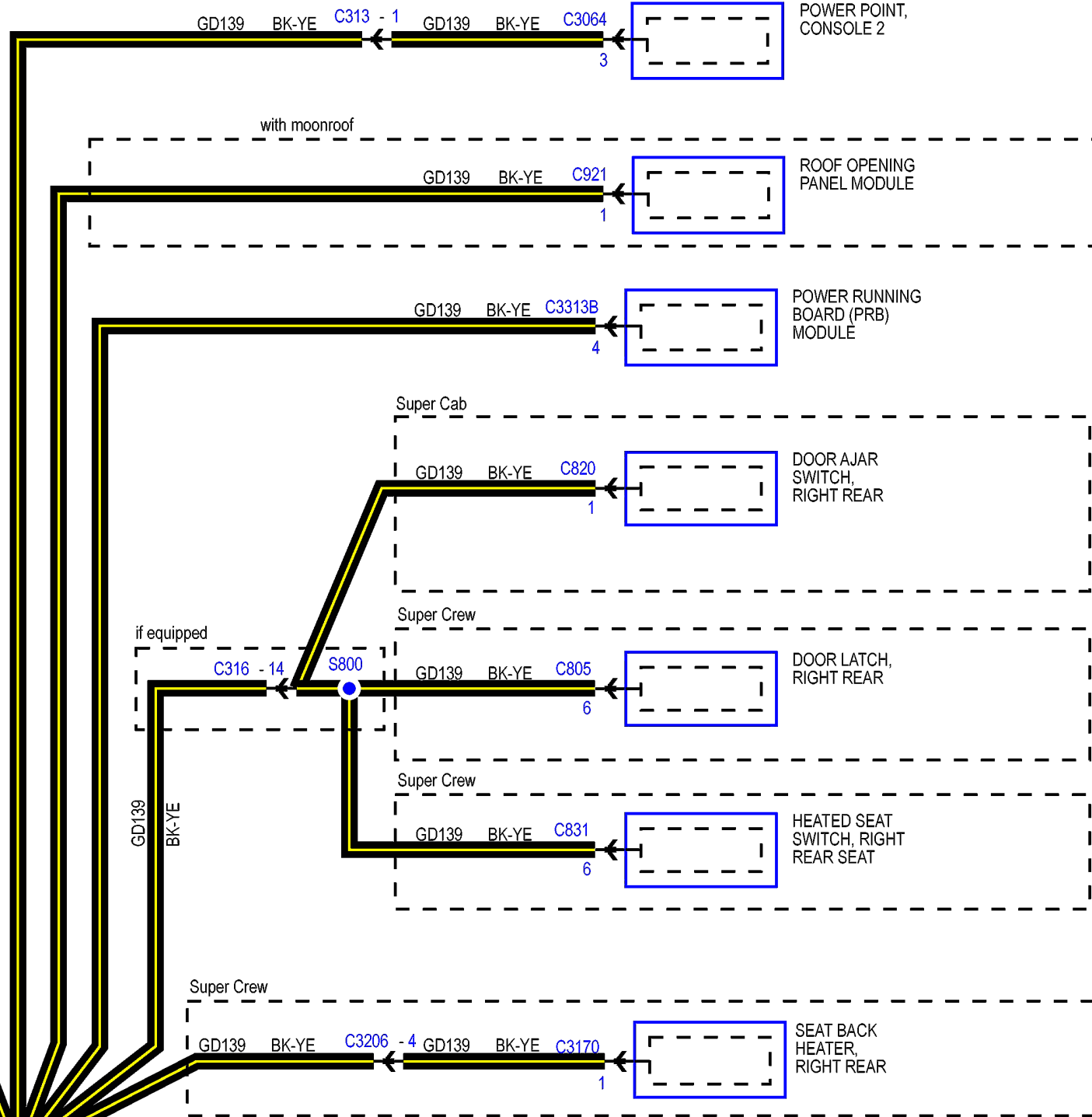
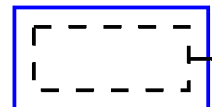
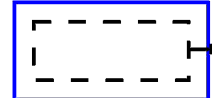

POWER POINT,
CONSOLE 2

with moonroof

ROOF OPENING
PANEL MODULE

POWER RUNNING
BOARD (PRB)
MODULE

Super Cab

DOOR AJAR
SWITCH,
RIGHT REAR

Super Crew

DOOR LATCH,
RIGHT REAR

Super Crew

HEATED SEAT
SWITCH, RIGHT
REAR SEAT

Super Crew

SEAT BACK
HEATER,
RIGHT REAR

G201

G201

with power equipment

EXTERIOR REAR VIEW MIRROR, PASSENGER SIDE

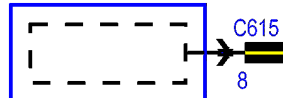

DOOR LOCK SWITCH, RIGHT FRONT

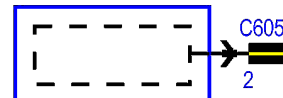

WINDOW CONTROL SWITCH, PASSENGER SIDE

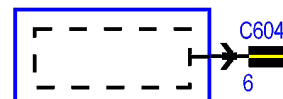

POWER WINDOW MOTOR, RIGHT FRONT

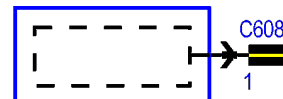

DOOR LATCH, RIGHT FRONT

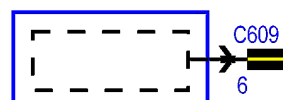

Regular Cab

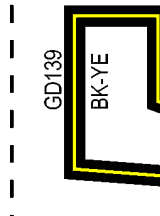

if equipped

C237

GD139 BK-YE

50

GD139 BK-YE

50

GD139 BK-YE

G201

if equipped

GD134 BK-VT

6

GD139 BK-YE

6

GD139 BK-YE

6

GD139 BK-YE

6

GD139 BK-YE

6

GD139 BK-YE

6

GD139 BK-YE

6

GD139 BK-YE

6

GD139 BK-YE

6

GD139 BK-YE

6

GD139 BK-YE

Regular Cab without power equipment

GD139 BK-YE

6

GD139 BK-YE

6

GD139 BK-YE

6

GD139 BK-YE

6

GD139 BK-YE

6

GD139 BK-YE

6

GD139 BK-YE

6

GD139 BK-YE

6

GD139 BK-YE

6

GD139 BK-YE

6

GD139 BK-YE

Regular Cab without remote keyless entry

C314 - 16

2

GD139 BK-YE

2

GD139 BK-YE

2

GD139 BK-YE

2

GD139 BK-YE

2

GD139 BK-YE

2

GD139 BK-YE

2

GD139 BK-YE

2

GD139 BK-YE

2

with climate controlled seats

GD903 BK-WH

M

GD903 BK-WH

M

GD903 BK-WH

M

GD903 BK-WH

M

GD903 BK-WH

M

S600

S350

C340

C330

C335

C3265A

C312

C901

C525

C615

C605

C604

C608

C609

DOOR LATCH, LEFT FRONT

DOME LAMP, FRONT

SEAT BACKREST HEATER MAT, PASSENGER SIDE

SEAT CONTROL SWITCH, PASSENGER SIDE FRONT

DUAL CLIMATE CONTROLLED SEAT MODULE (DCSM)

OVERHEAD
CONSOLE SWITCH
ASSEMBLY

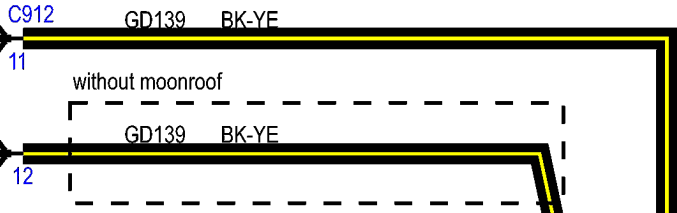
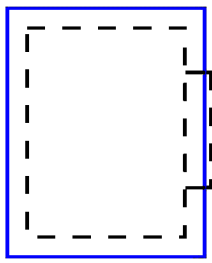

with overhead console

VANITY MIRROR
LAMP, RIGHT

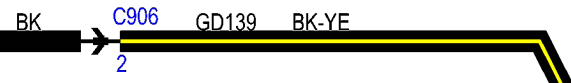
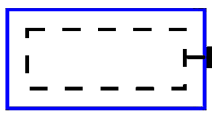

VANITY MIRROR
LAMP, LEFT

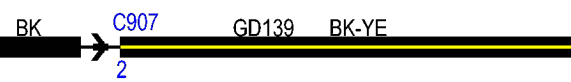
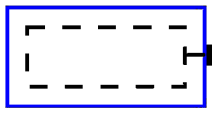

INTERIOR/MAP
LAMPS ASSEMBLY,
FRONT

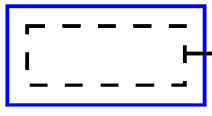

INTERIOR/MAP
LAMPS ASSEMBLY,
REAR

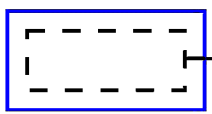

S903

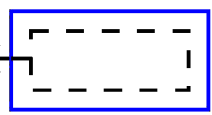

DOME LAMP,
FRONT

with moonroof

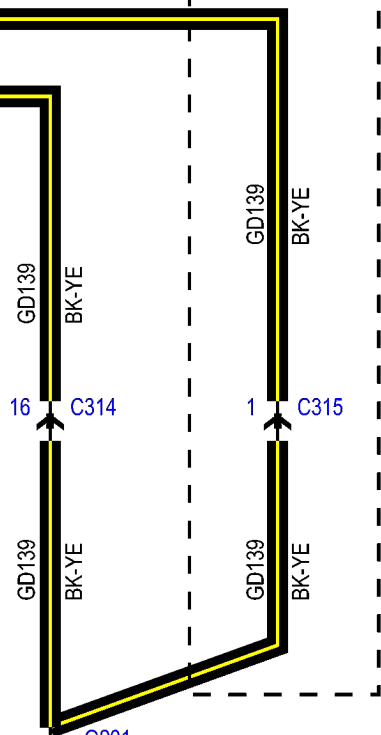

16

C314

1

C315

G201

G202

MODE SELECT SWITCH (MSS)

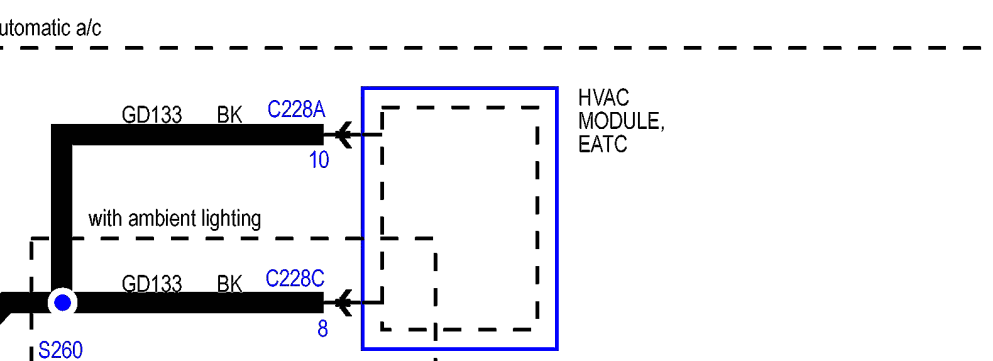
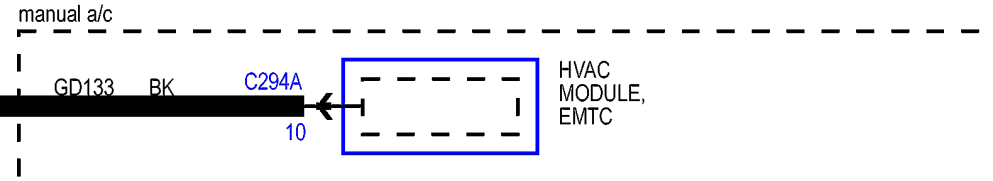
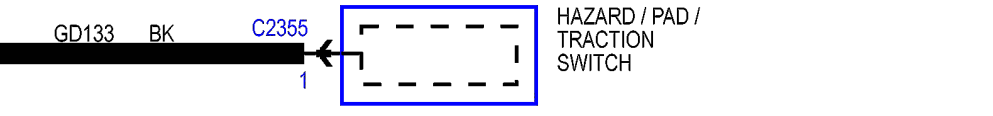
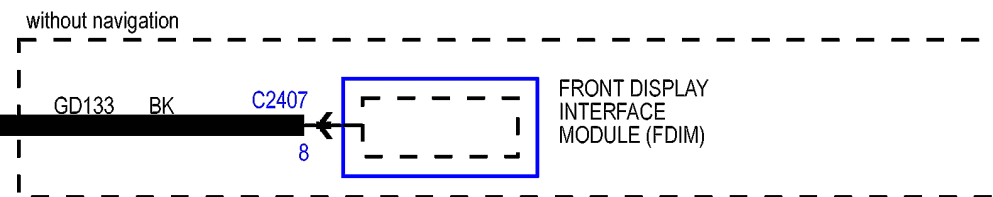
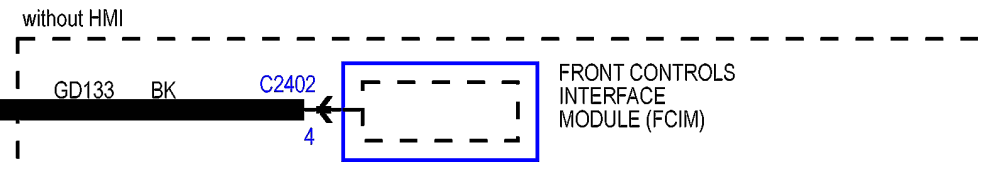
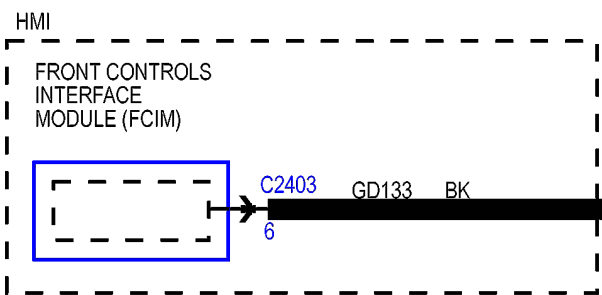
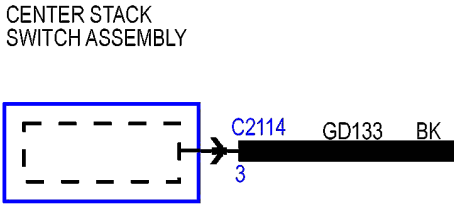
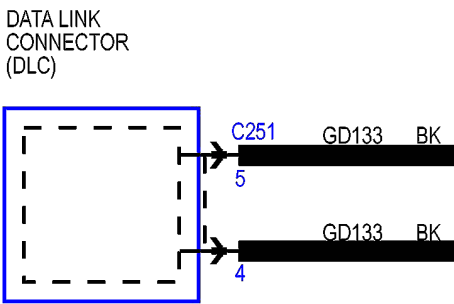
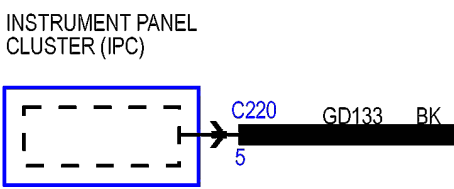
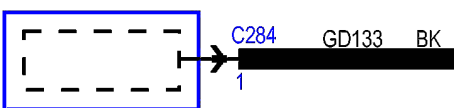

G202

G202

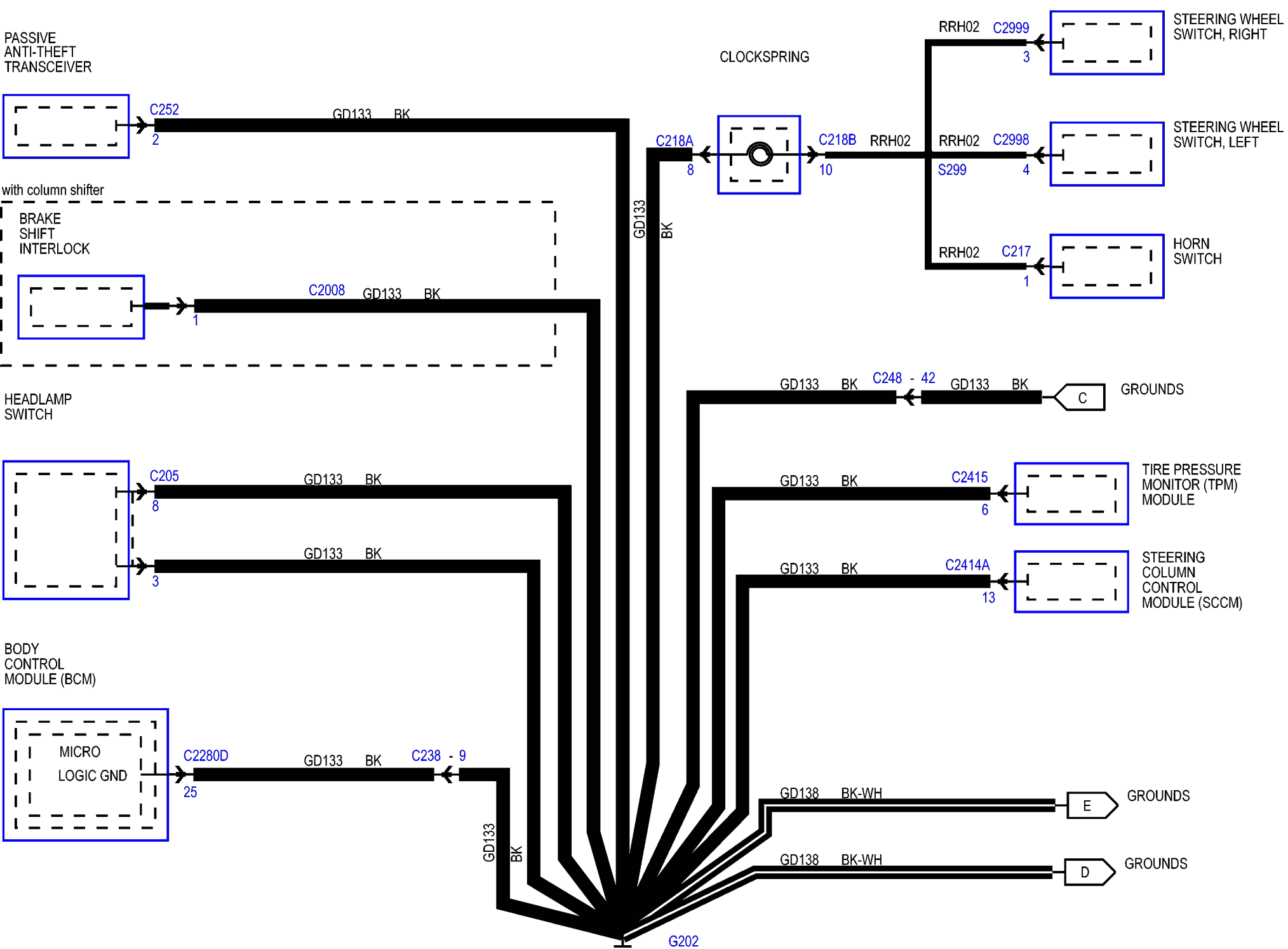

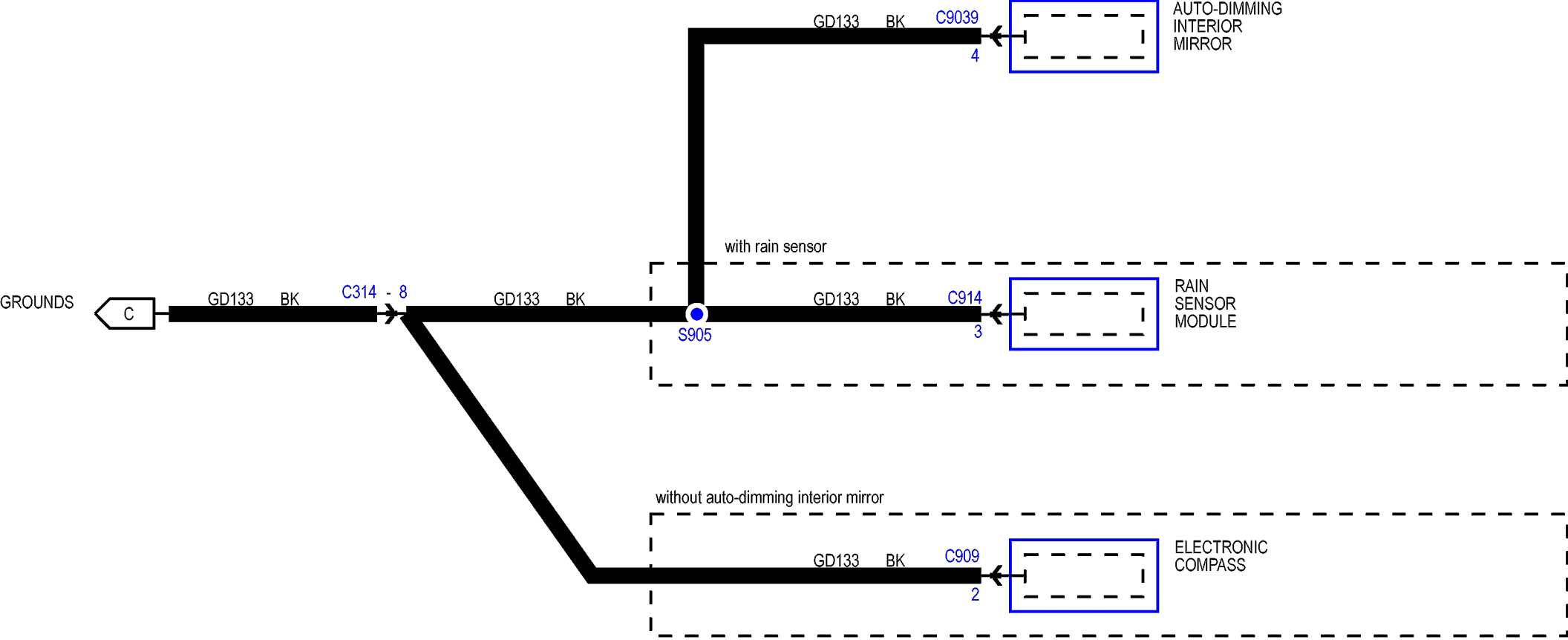

G203

with floor shifter

SVT Raptor

HILL DESCENT CONTROL SWITCH



OFF-ROAD MODE SWITCH

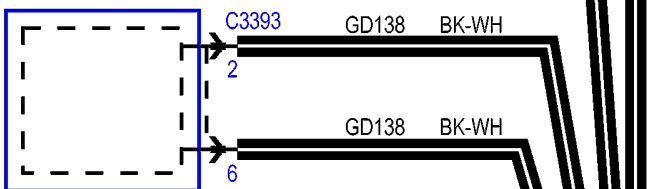

UPFITTER SWITCH

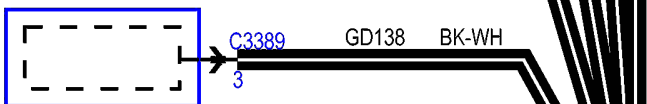

POWER POINT, CONSOLE 1

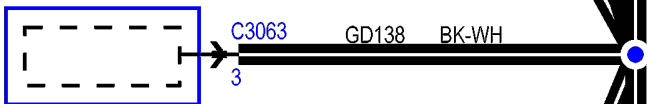

POWER POINT, CONSOLE 2

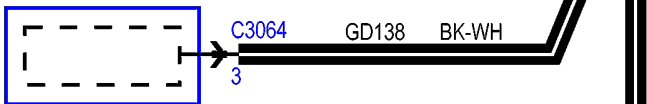

FLOOR SHIFTER

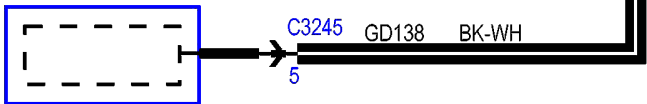

GROUNDS



GD138 BK-WH

GROUNDS



GD138 BK-WH

GD138 BK-WH

33 C329

GD138 BK-WH

G203

Crew Chief

GND1 BK-GY C2409 1

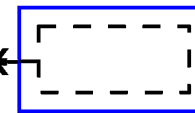

TELEMATICS MODULE

C2108 - 3 GND-B BK-GY S273 GND-A BK-GY C2142 3

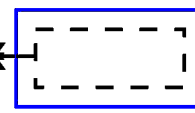

TRAILER BRAKE CONTROL (TBC) MODULE

GD138 BK-WH C2033 3

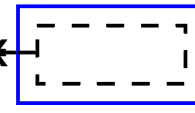

POWER POINT, INSTRUMENT PANEL

GD138 BK-WH C2031 3

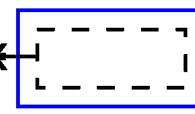

CIGAR LIGHTER, FRONT

with manual a/c

GD138 BK-WH C294B 5

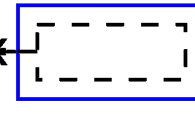

HVAC MODULE, EMTC

GD138 BK-WH C2185 4

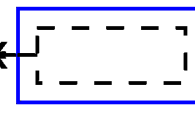

BLOWER MOTOR RESISTOR

with automatic a/c

GD138 BK-WH C271 1

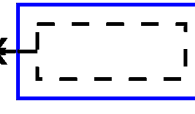

BLOWER MOTOR SPEED CONTROL

with adjustable pedal / tilt/telescope column

GD138 BK-WH C2414B 5

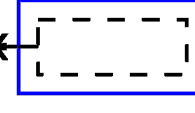

STEERING COLUMN CONTROL MODULE (SCCM)

10 C264

with column shifter

GD138 BK-WH C2293A 6

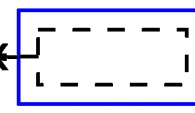

DC/AC INVERTER MODULE

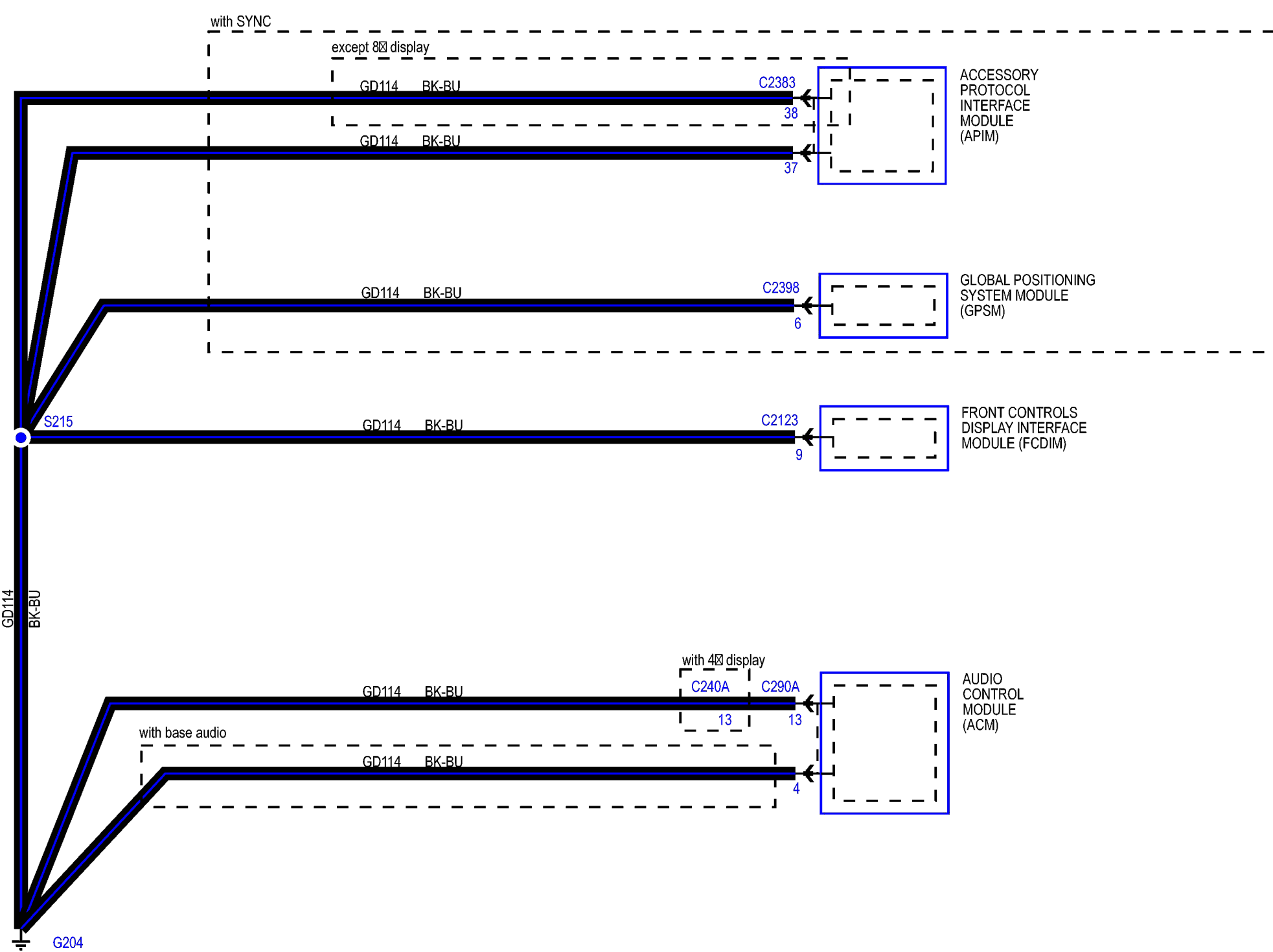

G300

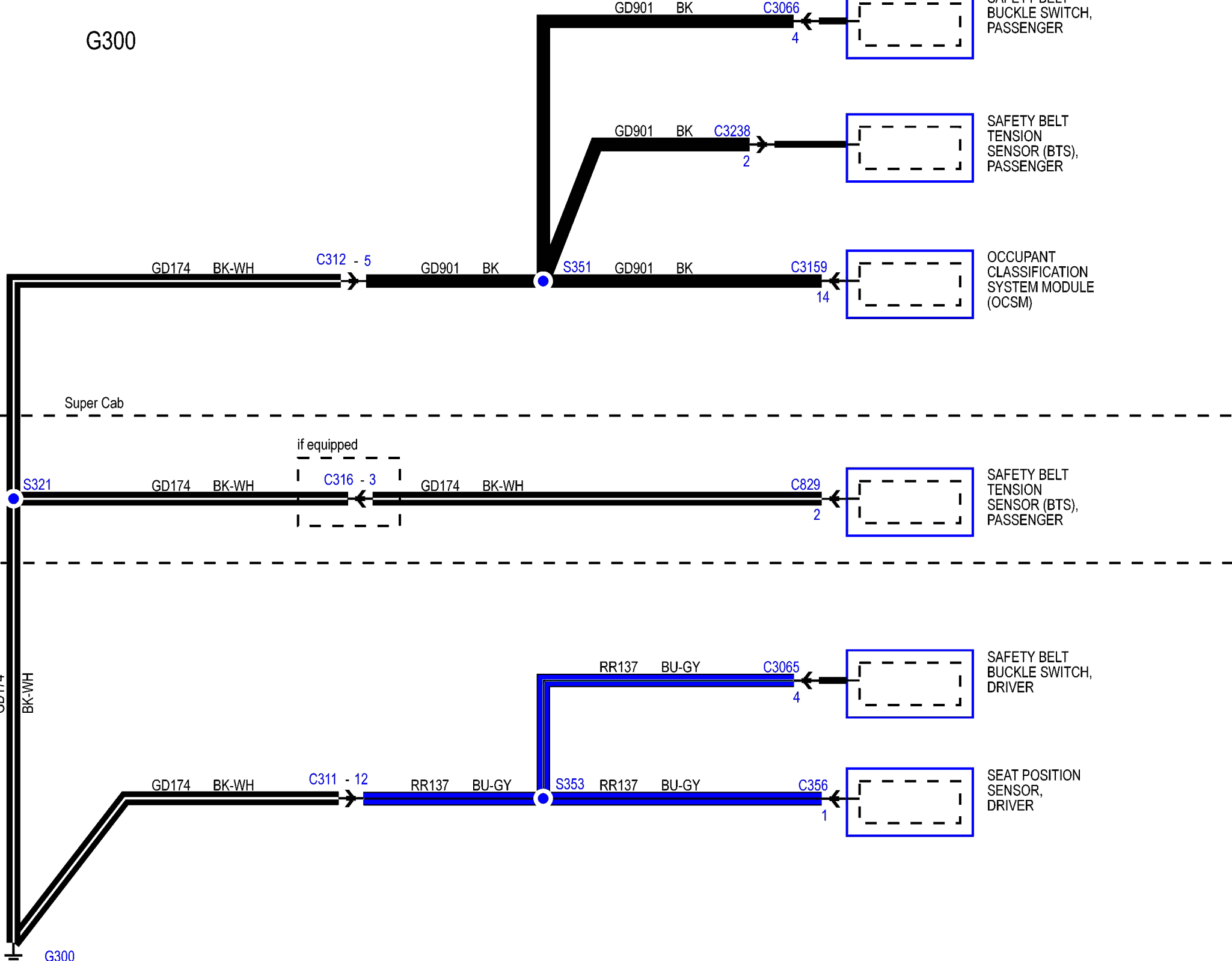

SAFETY BELT BUCKLE SWITCH, PASSENGER

SAFETY BELT TENSION SENSOR (BTS), PASSENGER

OCCUPANT CLASSIFICATION SYSTEM MODULE (OCSM)

SAFETY BELT TENSION SENSOR (BTS), PASSENGER

SAFETY BELT BUCKLE SWITCH, DRIVER

SEAT POSITION SENSOR, DRIVER

Super Cab

if equipped

GD174 BK-WH

G300

G300

GD901 BK

C3066

4

GD901 BK

C3238

2

GD174 BK-WH

C312 - 5

GD901 BK

S351

GD901 BK

C3159

14

Super Cab

S321

GD174 BK-WH

C316 - 3

GD174 BK-WH

C829

2

RR137 BU-GY

C3065

4

GD174 BK-WH

C311 - 12

RR137 BU-GY

S353

RR137 BU-GY

C356

1

G300

G301, G400

with SONY® sound

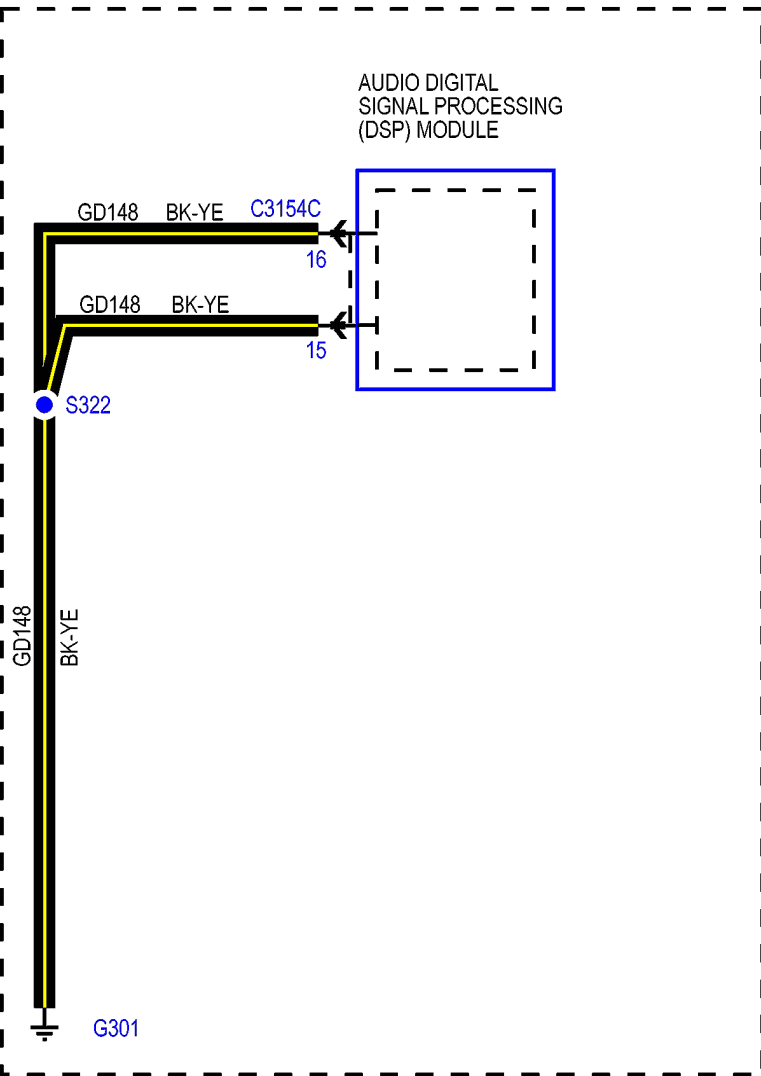

7-pin trailer tow

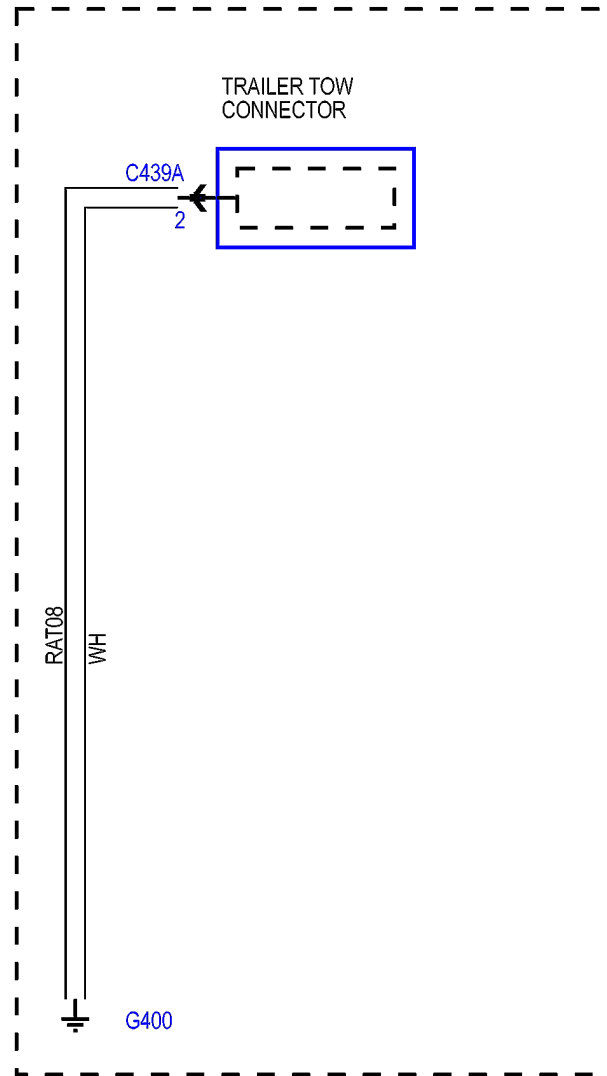

4-pin trailer tow

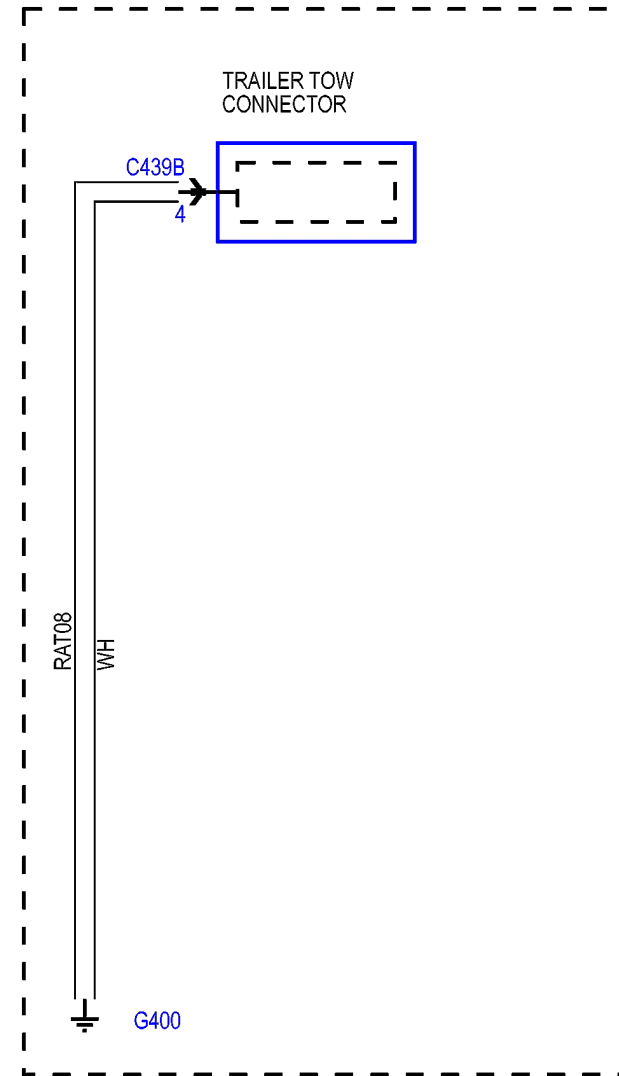

G401

LICENSE
PLATE LAMP,
RIGHT

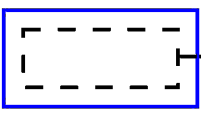

LICENSE
PLATE LAMP,
LEFT

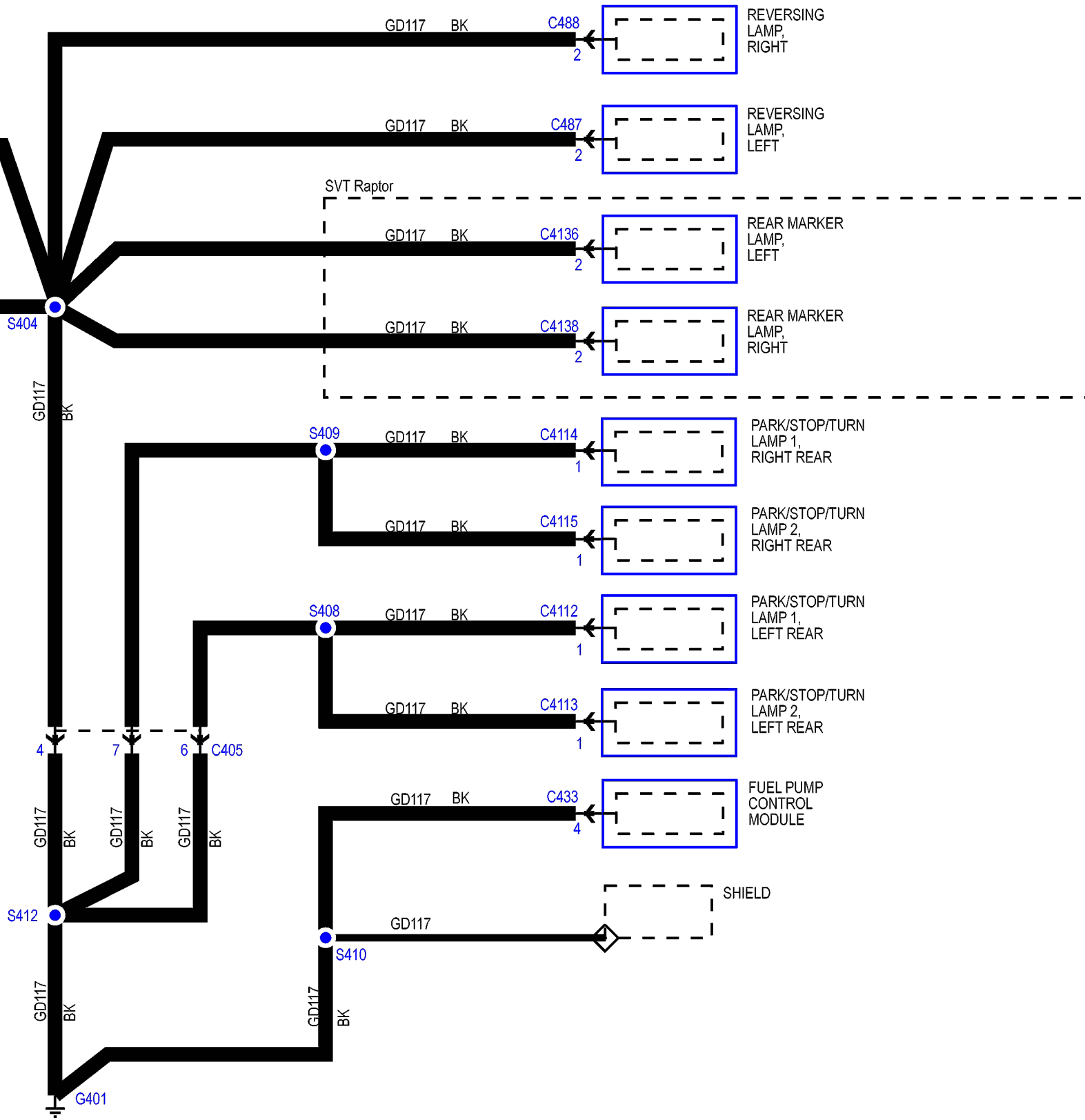
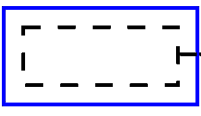

GD117 BK

C488

REVERSING
LAMP,
RIGHT

GD117 BK

C462

1

GD117 BK

C487

REVERSING
LAMP,
LEFT

SVT Raptor

GD117 BK

C4136

REAR MARKER
LAMP,
LEFT

GD117 BK

C452

1

S404

GD117 BK

C4138

REAR MARKER
LAMP,
RIGHT

GD117
BK

GD117 BK

C4114

PARK/STOP/TURN
LAMP 1,
RIGHT REAR

GD117 BK

C4115

PARK/STOP/TURN
LAMP 2,
RIGHT REAR

GD117 BK

C4112

PARK/STOP/TURN
LAMP 1,
LEFT REAR

GD117 BK

C4113

PARK/STOP/TURN
LAMP 2,
LEFT REAR

4

7

6

C405

GD117
BK

GD117
BK

GD117
BK

GD117 BK

C433

FUEL PUMP
CONTROL
MODULE

S412

GD117

SHIELD

GD117
BK

S410

GD117
BK

GD117
BK

G401