



TECHNICAL SERVICE BULLETIN

Difficulty Unlatching Or Latching Doors In Freezing Ambient Temperatures - Built On Or After 4-Apr-2018

19-2007
18 January
2019

Model:

Ford 2018-2019 F-150
2018-2019 F-Super Duty

Issue: Some 2018-2019 F-150 vehicles built at Kansas City Assembly Plant on or after 4-Apr-2018 and Dearborn Truck Plant on or after 13-Apr-2018 and some F-Super Duty vehicles built at Kentucky Truck Plant on or after 22-Apr-2018 and Ohio Assembly Plant on or after 18-Apr-2018 may exhibit doors that are difficult to unlatch or latch in temperatures at or below freezing.

Action: Follow the Service Procedure steps to correct the condition.

Parts

Part Number	Description	Quantity
FL3Z-16308-M	Front Door Kit	1
FL3Z-16308-N	Rear Door Kit (Crew Cab Only)	1
XL-6	Motorcraft® Silicone Spray	1
TA-30	Motorcraft® Silicone Sealant	1
XG-13	Motorcraft® Door Latch Grease	1
ZC-32-B2	Motorcraft® Premium Windshield Wash Concentrate (USA)	1
Obtain Locally	Methyl Hydrate Or Equivalent Product Containing 99 Percent Methanol (Canada)	1
Obtain Locally	Isopropyl Alcohol	1
Obtain Locally	Cotton Swabs	1
Obtain Locally	Syringe, Eye Dropper or similar applicator	1
Obtain Locally	Disposable Gloves	1

Warranty Status: Eligible Under Provisions Of New Vehicle Limited Warranty Coverage Warranty/ESP coverage limits/policies/prior approvals are not altered by a TSB. Warranty/ESP coverage limits are determined by the identified causal part and verified using the OASIS part coverage tool.

Labor Times

Description	Operation No.	Time
2018-2019 F-150/Super Duty Regular And Super Cab: Follow The Service Procedure To Repair Both (2) Front Doors (Do Not Use With Any Other Labor Operations)	192007A	1.9 Hrs.
	192007B	

2018-2019 F-150 SuperCrew, F-Super Duty Crew Cab: Follow The Service Procedure To Repair All Four (4) Doors (Do Not Use With Any Other Labor Operations)

3.3
Hrs.

Repair/Claim Coding

Causal Part:	1521813
Condition Code:	42

Tool List

Drive	Tool Name
1/4"	Power Tool
1/4"	Ratchet
1/4"	Torque Wrench
1/4"	6" Extension
1/4"	7 mm Socket
1/4"	8 mm Socket
1/4"	10 mm Socket
1/4"	Torx® T20
1/4"	Torx® T25
1/4"	Torx® T27
	Small Trim Tool
	Caulk Gun
	Scissors
	Ruler / Straight Edge
	Paint Pen
	Brushes
	Utility Knife
	Pocket Screwdriver
	Blow Gun
	10 mm Wrench
	Small Pick
	Needle Nose Pliers
	Flashlight
	Shop Towel
	Isopropyl Alcohol
	Bungee Cords
	Body Tape

Service Procedure

1. Is the vehicle an F-150 built at Kansas City Assembly Plant on or after 4-Apr-2018 or Dearborn Truck Plant on or after 13-Apr-2018 or an F-Super Duty vehicle built at Kentucky Truck Plant on or after 22-Apr-2018 and Ohio Assembly Plant on or after 18-Apr-2018?

(1). Yes - proceed to step 2.

(2). No - this article does not apply. Refer to the Workshop Manual (WSM), Section 501-14 for normal diagnostics.

2. Remove the front exterior door handle. Refer to WSM, Section 501-14. Do not allow the door trim panel or exterior door handle to hang from the cables.

NOTE: The interior grab handle cover clips can be reused for this repair.

3. Using compressed air, blow out any debris or residual water from the door latch assembly, exterior door handle mechanism, and cables. (Figure 1)

Figure 1

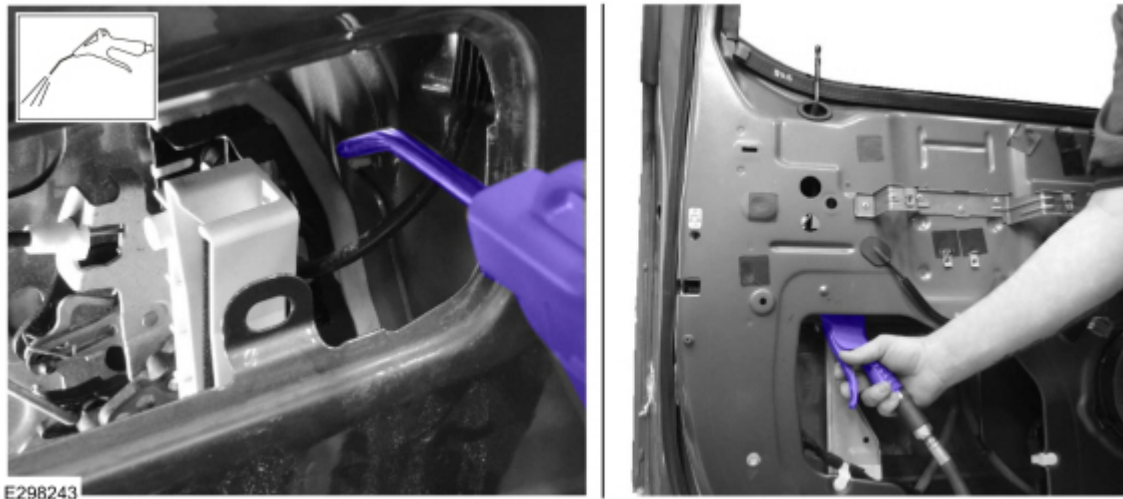

4. Lower the front door glass to the fully down position.

5. Remove the inner belt moulding and position the latch side of the door glass top run aside. Refer to WSM, Section 501-11. (Figures 2 - 3)

Figure 2

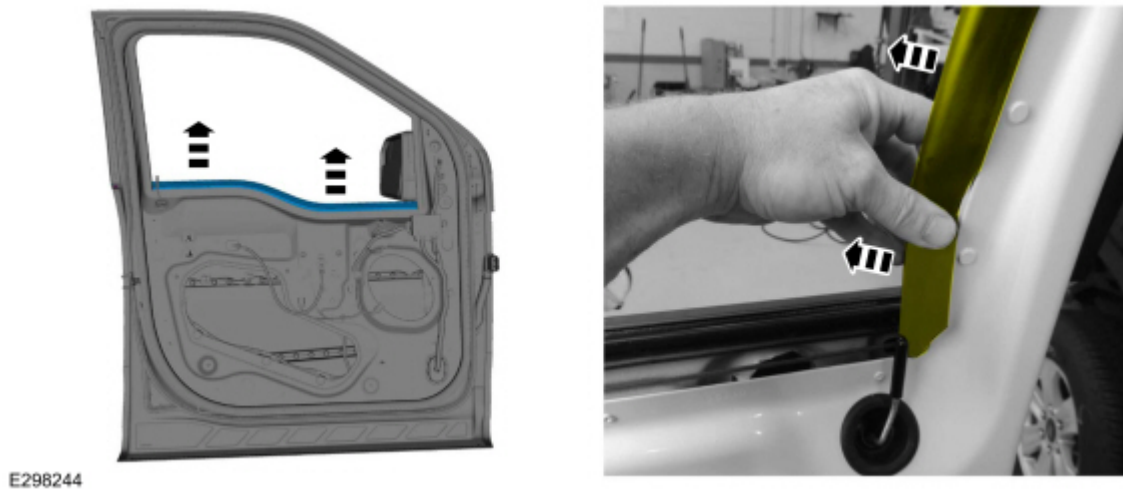
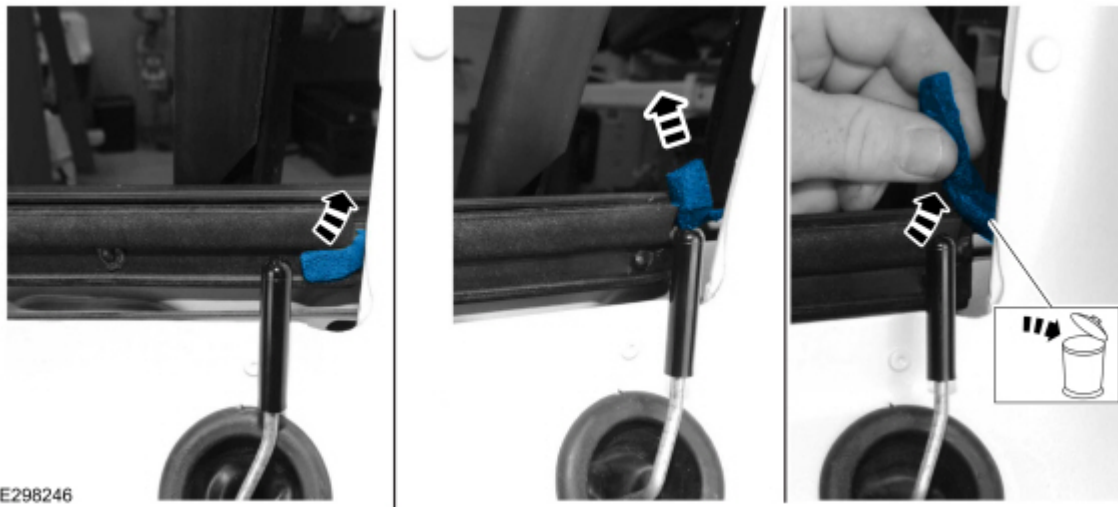

Figure 3



6. If present, remove the foam on the driver and passenger side outer belt moulding as shown in Figure 4.

Figure 4



7. Using a clean cloth and isopropyl alcohol, clean the area shown in Figure 5.

Figure 5



8. Apply a small bead of Motorcraft® Silicone Sealant onto the area of the outer belt moulding highlighted in Figure 6. Make sure the two belt moulding clips are completely covered. Using your finger, smooth out the sealer to establish an even surface. (Figure 6)

Figure 6

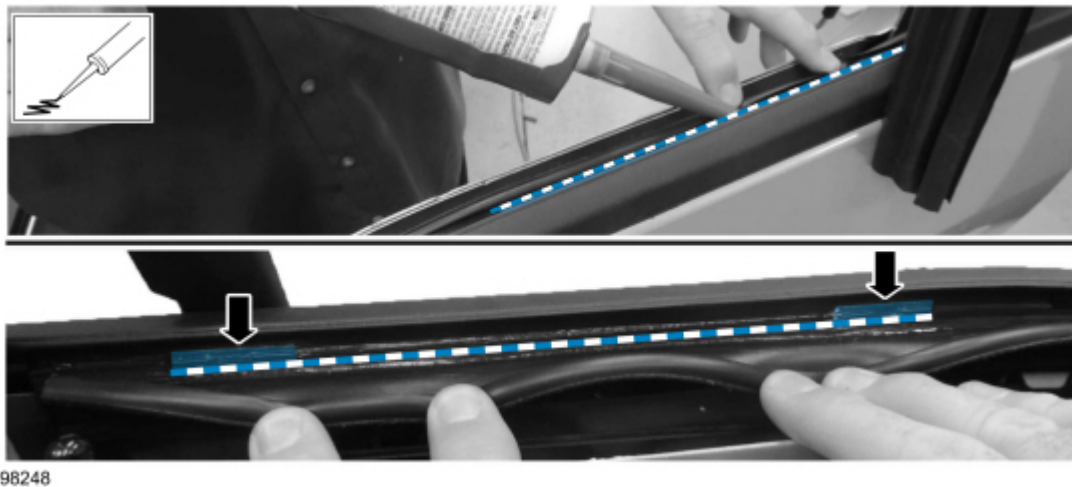

9. Using a small trim removal tool, install Foam 1 (Figure 7 Callout 1) to the outer belt moulding on top of the bead of silicone that was applied in Step 8. Both outer belt moulding clips need to be covered by Foam 1. The end of the foam wraps around as shown in Figure 9. (Figures 7 - 9)

Figure 7

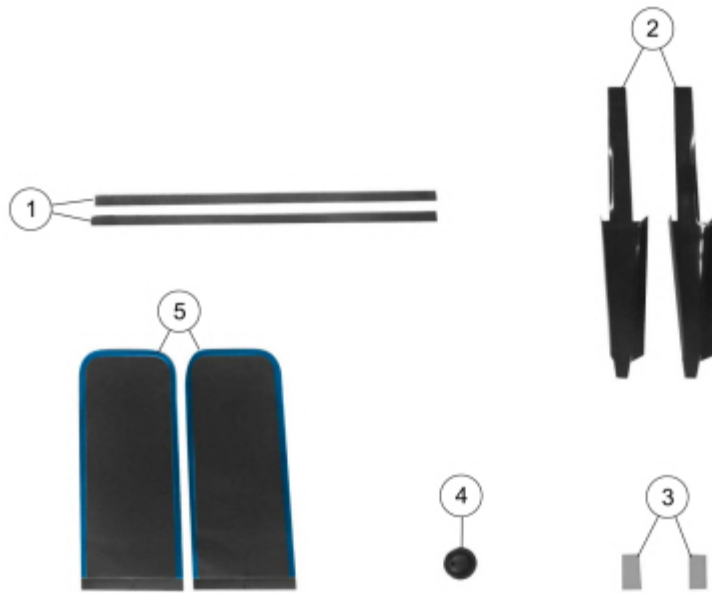

E298249

Item	Description
1	Foam 1
2	Door glass run funnel
3	Foam tape
4	Rubber grommet
5	Exterior door handle gasket

Figure 8



E298250

Figure 9

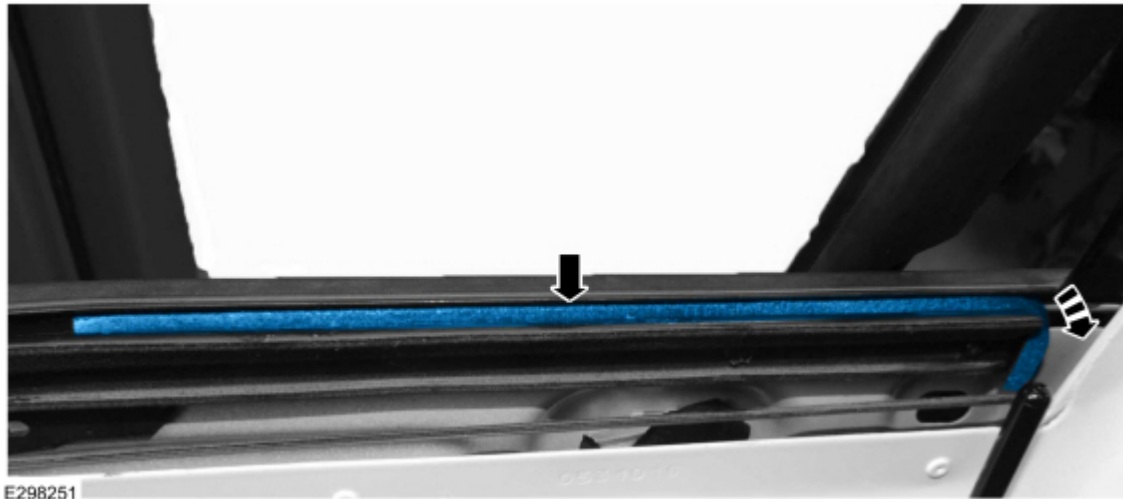

10. Using a clean cloth and isopropyl alcohol, remove any excess silicone in visible areas on the outer belt moulding.

11. Inspect the black plastic funnel received in the parts kit. Refer to Attachment V of Field Service Action (FSA) 18N03 to verify the correct size funnel was included in the kit. If a door foam kit is found to have the incorrect size door glass run funnels, the correct size door glass run funnels can be removed from another kit. The additional kit the door glass run funnels were removed from can also be claimed with this repair. Discard unused parts from the additional kit.

(1). Install the black plastic door glass run funnel. (Figure 7 Callout 2) Make sure the lower tab is seated correctly in the door glass run and the funnel legs sit at a 90 degree angle above the door glass run. (Figure 10)

Figure 10

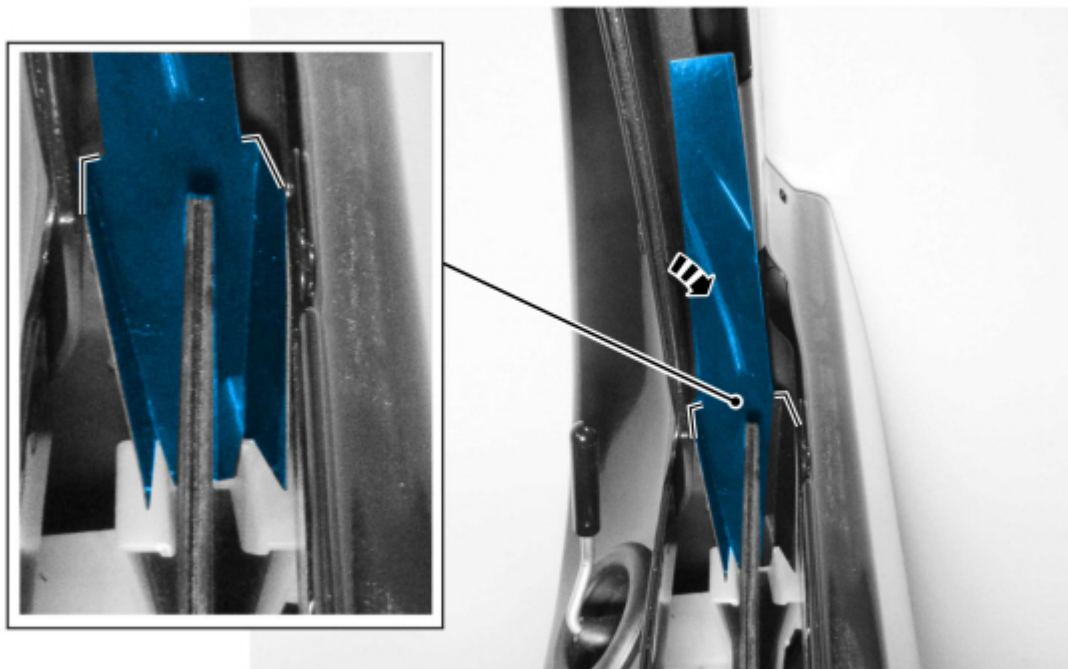

E298252

12. Reinstall the latch side of the front door glass top run and inner belt moulding. Refer to WSM, Section 501-11. It is necessary to hold the upper portion of the funnel when installing the door glass top run. Care should be taken not to bend or damage the door glass run funnel.

13. Unseat the door lock rod grommet and visually make sure the funnel is in the correct position and reinstall the front door lock rod grommet. (Figure 11)

Figure 11

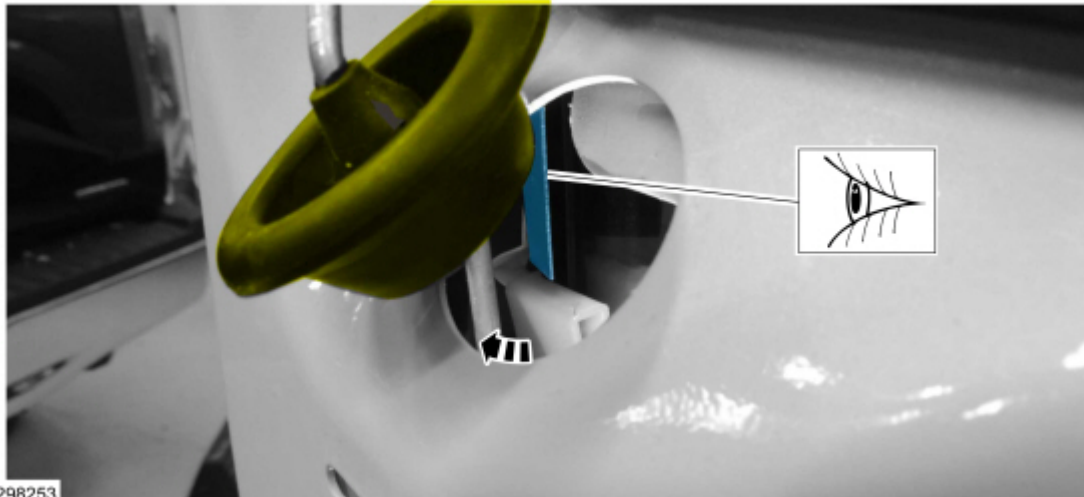

14. Raise the front door glass to the fully up position.

15. Using your hand, install the foam tape (Figure 7 Callout 3) on the top of the door glass run and on the back of the door glass run funnel in the order shown in Figure 12. (Figures 12 - 13)

Figure 12

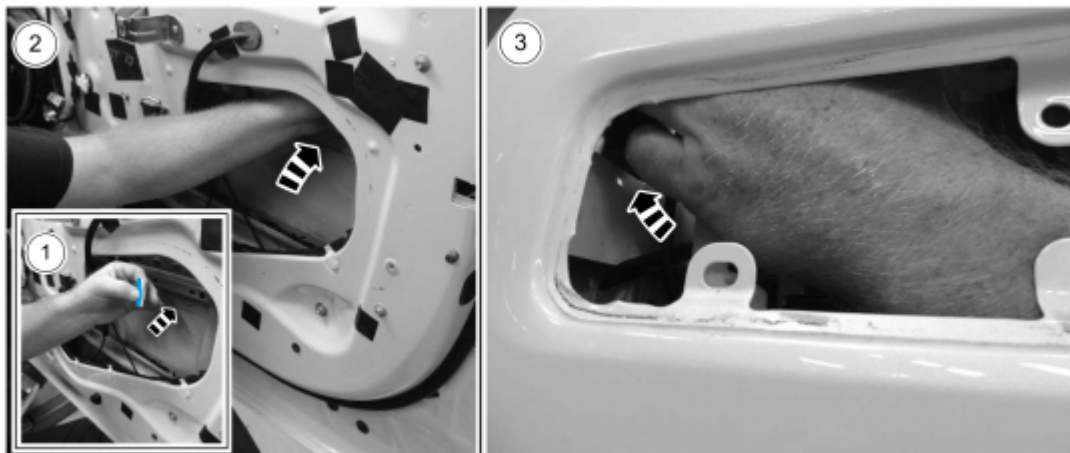
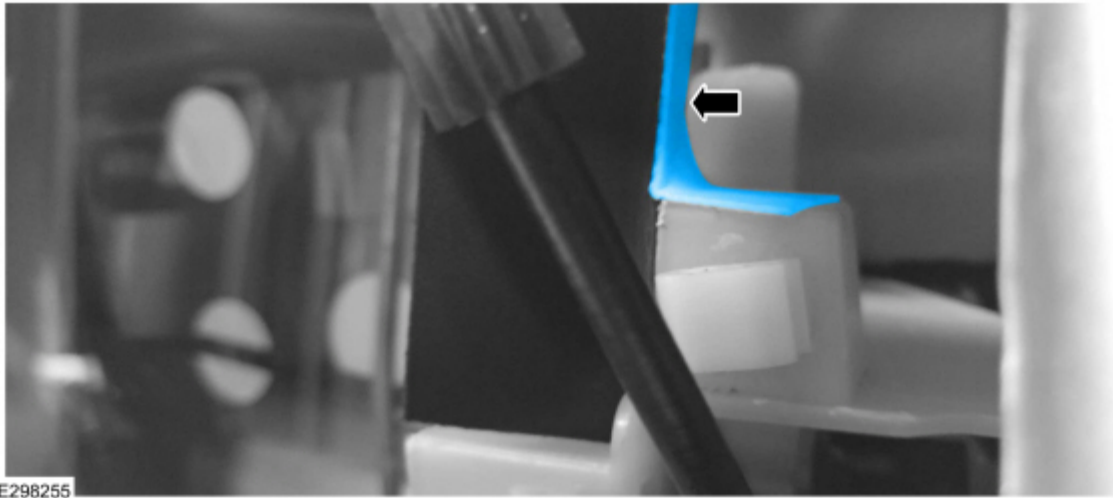
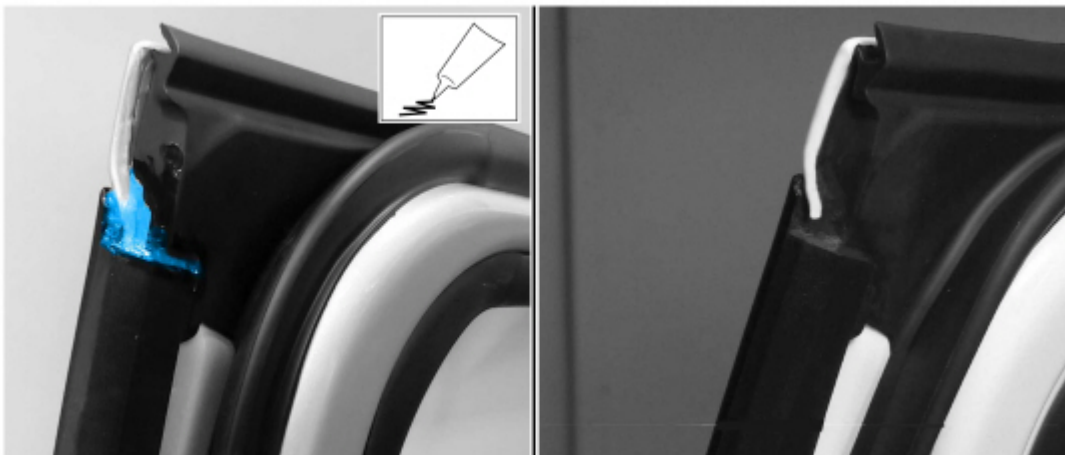

Figure 13



16. Using isopropyl alcohol, clean the top portion of the door and neatly apply Motorcraft® Silicone Sealant completely filling the gap shown in Figure 14. Do not close the door until the silicone sealer has cured.

Figure 14



17. On the driver's side door only, apply Motorcraft® Door Latch Grease to the area where the key lock rod attaches to the key lock rod lever. (Figure 15)

Figure 15

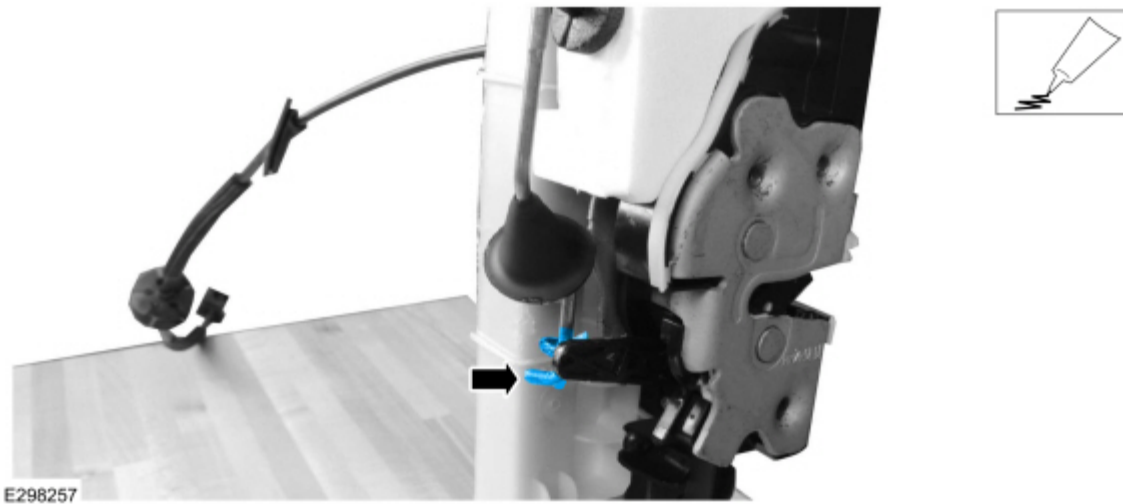

- 18.** On the driver's side door only, install the rubber grommet (Figure 7 Callout 4) onto the key lock rod over the key lock rod lever. Position the rubber grommet down as shown in Figure 16. The rubber grommet will sit sideways when properly installed.

Figure 16



E298258

19. Inspect the interior door handle to latch cable for kinking. If necessary, straighten any kinks in the cable by hand. (Figure 17)

Figure 17

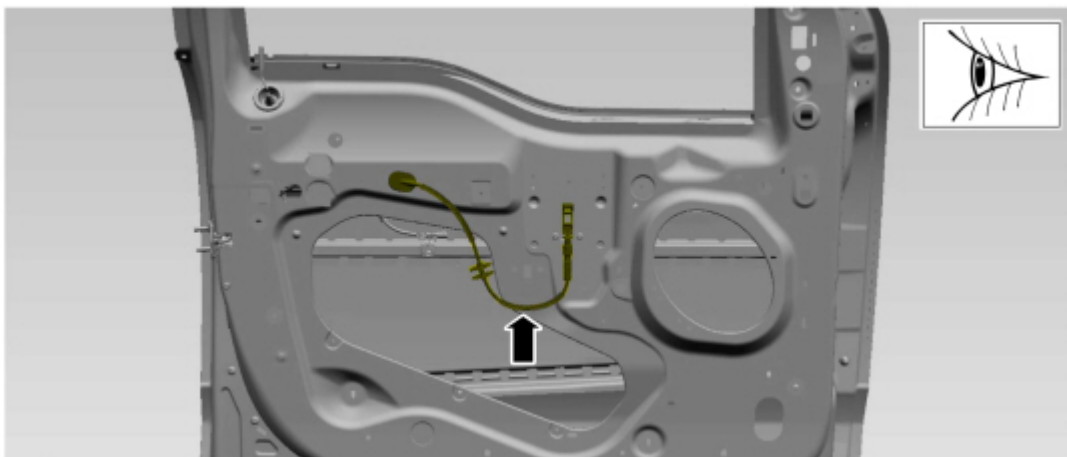

E298259

20. Unseat the interior door handle cable rubber grommet and release any cable retaining clips. Hold the end of the cable in the upright position and spray Motorcraft® Silicone Spray for 5 seconds into the cable. (Figure 18)

Figure 18

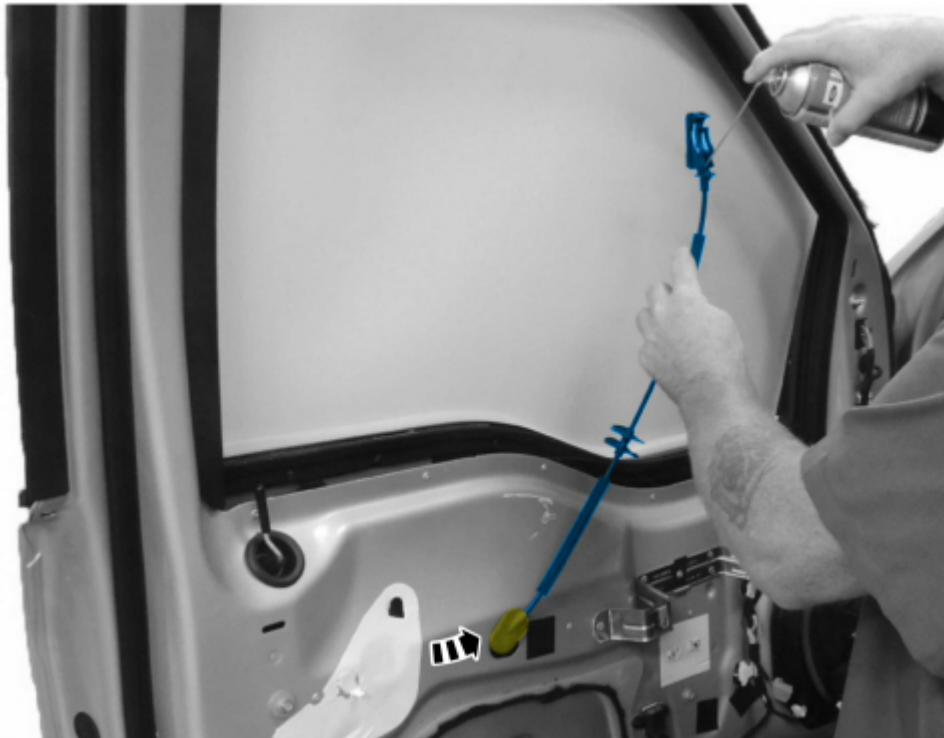

E298260

21. Using a bungee cord or other suitable device, secure the interior door handle cable to the door in the upright position to allow the lubricant time to run down into the cable. (Figure 19)

Figure 19

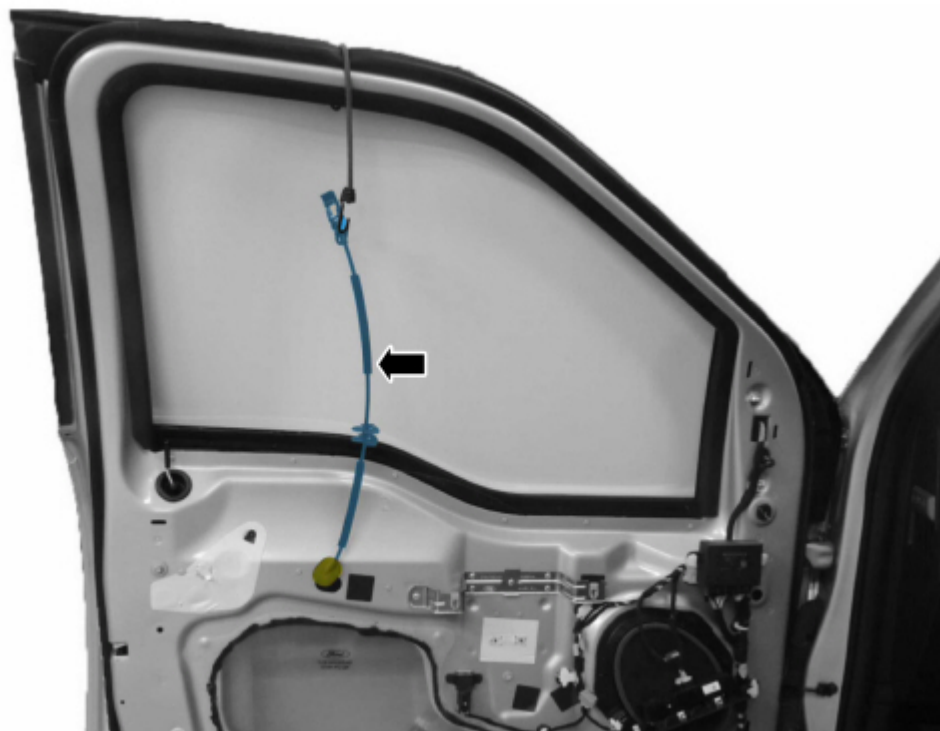

E298261

22. Towel dry the exterior door handle cable to absorb any residual moisture. Using a bungee cord or other similar device, secure the exterior door handle cable to the door in an upward position as shown in Figure 20, to allow the undiluted Motorcraft® Premium Windshield Wash Concentrate or a 99 percent methyl hydrate (methanol) product time to run down into the cable, until the exterior door handle cable is reinstalled later in this procedure.

Figure 20



CAUTION: The use of disposable gloves is required for this step.

23. Place a shop towel around the exterior door handle cable as shown in Figure 20 to prevent dripping of the product onto any vehicle surface. Using a syringe, eye dropper, or other suitable applicator draw 10 ml of undiluted Motorcraft® Premium Windshield Wash Concentrate or 99 percent methyl hydrate (methanol) into the applicator. Do not use products containing isopropyl alcohol. With the cable pulled out and the tip of the applicator positioned inside the arrowhead cable end fitting, inject 2 ml between the cable shield and the cable then cycle the cable 5 times in and out of the cable shield. Repeat injecting the fluid and cycling the cable a total of 5 times.

24. Using a clean shop cloth and isopropyl alcohol, clean the mating surface area of the exterior front door handle as shown in Figure 21.

Figure 21

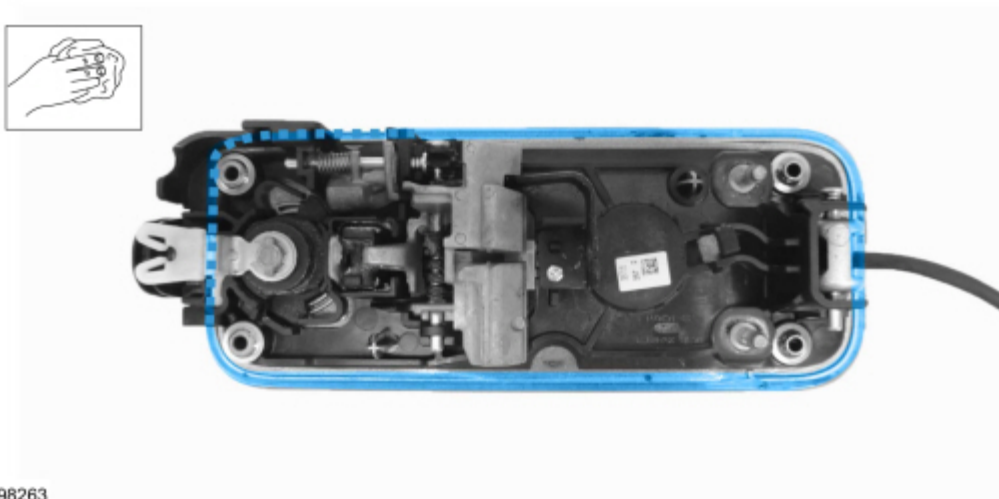

E298263

25. Using a clean shop cloth and isopropyl alcohol, clean inside the area shown in Figure 22 on the mating surface area of the front exterior door handle opening.

Figure 22

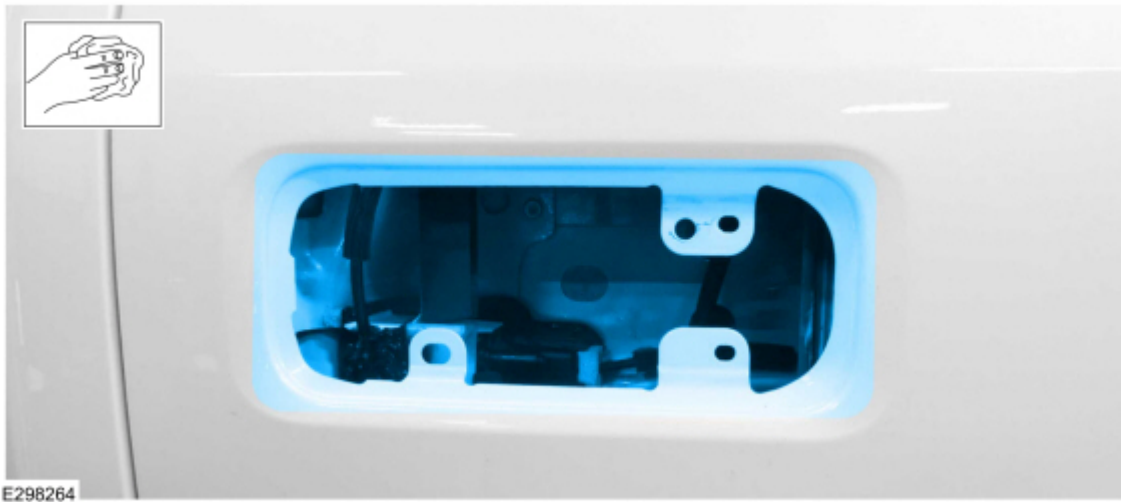

E298264

26. Install a new foam exterior door handle gasket. (Figure 7 Callout 5) Make sure the foam is aligned properly as shown in Figure 24. (Figure 23 - 24)

Figure 23

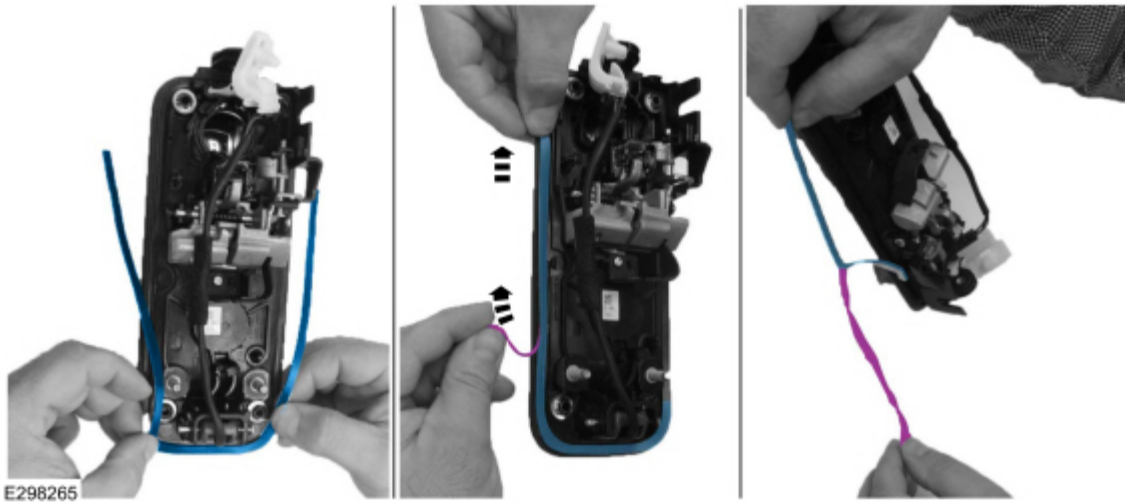

E298265

Figure 24

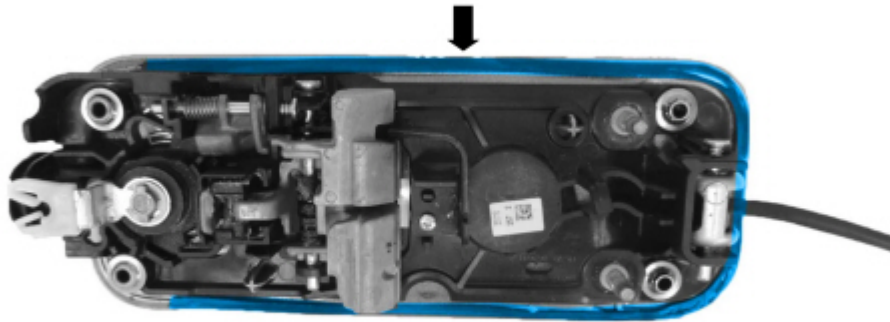

E298266

27. Using a clean shop cloth and isopropyl alcohol, clean the handle plunger then lightly apply Motorcraft® Door Latch Grease to all four sides of the exterior door handle plunger and to the mechanism shown in Figures 25 - 26.

Figure 25

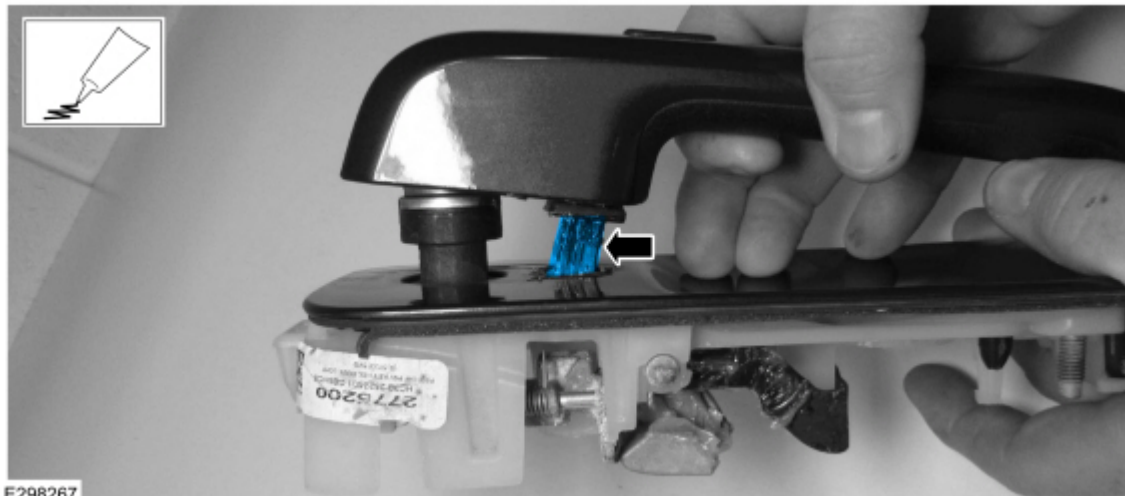

E298267

Figure 26

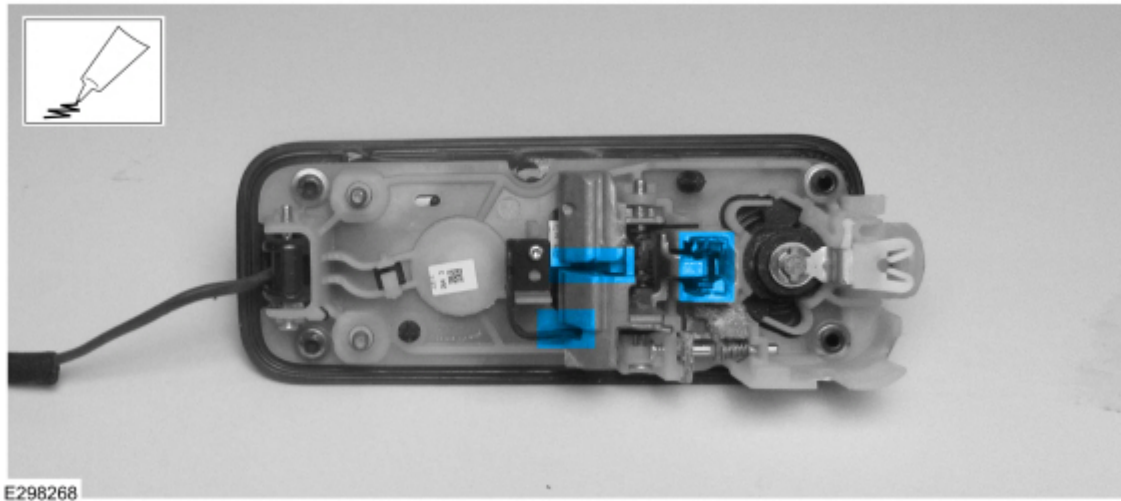

- 28.** Apply a bead of Motorcraft® Silicone Sealant to the latch side area of the front door exterior handle opening metal surface. (Figure 27) Make sure the sealant overlaps with the foam on the exterior door handle. (Figure 27)

Figure 27

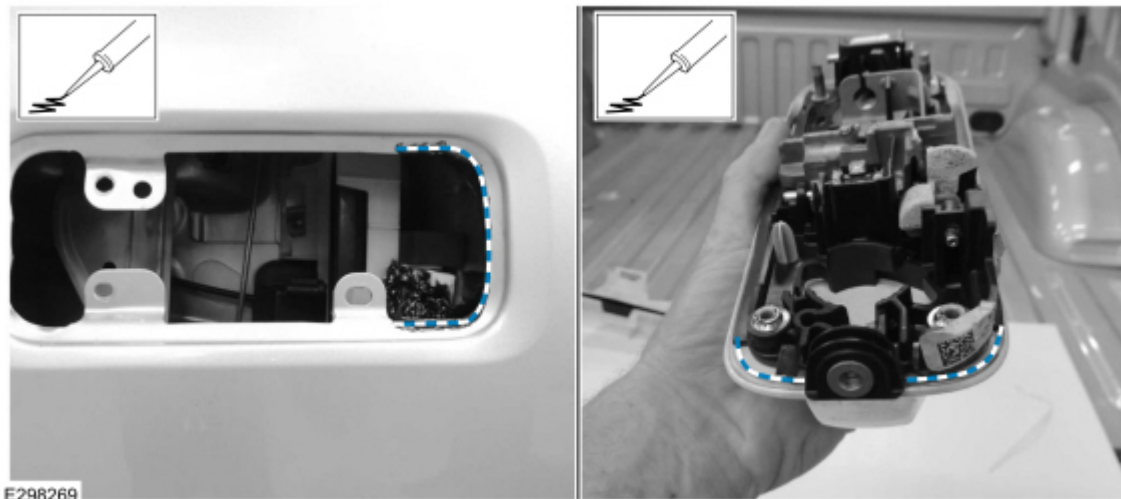

- 29.** Remove the bungee cord holding the interior door handle cable, seat the rubber grommet and, if equipped, reinstall interior door handle cable retaining clips.
- 30.** Install the exterior front door handles. When connecting the exterior door handle cable to the door handle, lubricate the cable with a thin layer of Motorcraft® Door Latch Grease as shown in Figure 28. Refer to WSM, Section 501-14.

Figure 28

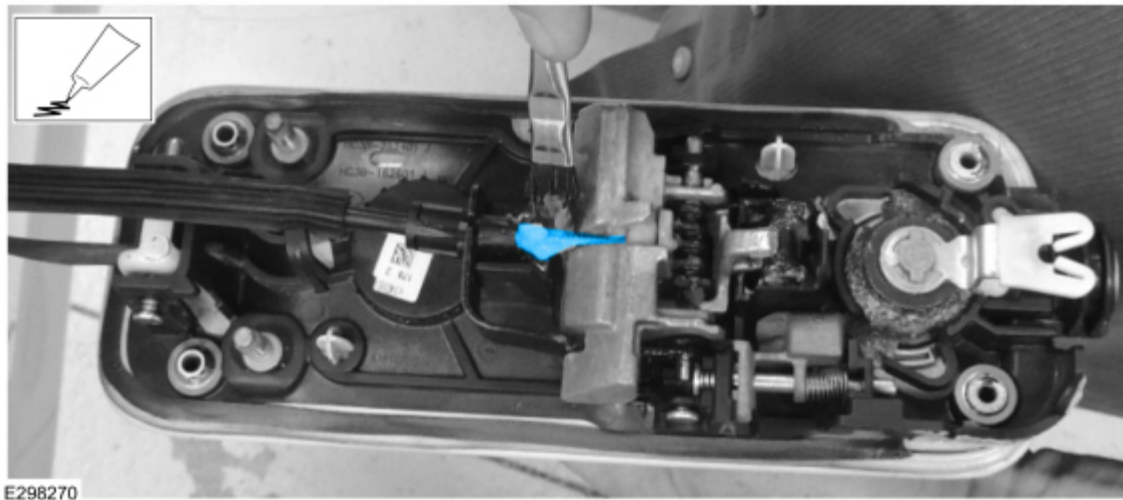

31. Clean any excess silicone around the exterior door handle perimeter using isopropyl alcohol, cotton swabs, and a clean shop cloth to avoid appearance concerns.
32. Repeat Steps 2 through 31 on the other front door.
33. Is the vehicle a crew cab?
 - (1). Yes - proceed to Step 34.
 - (2). No - repair is complete.
34. Remove the rear exterior door handle. Refer to WSM, Section 501-14. Do not allow the door trim panel or exterior door handle to hang from the cables.
35. Using compressed air, blow out any debris or residual water from the door latch assembly, exterior door handle mechanism, and cables. (Figure 1)
36. Lower the rear door window glass to the fully down position.
37. Remove the rear door inner belt moulding and position the latch side of the door glass top run aside. (Figure 29)

Figure 29

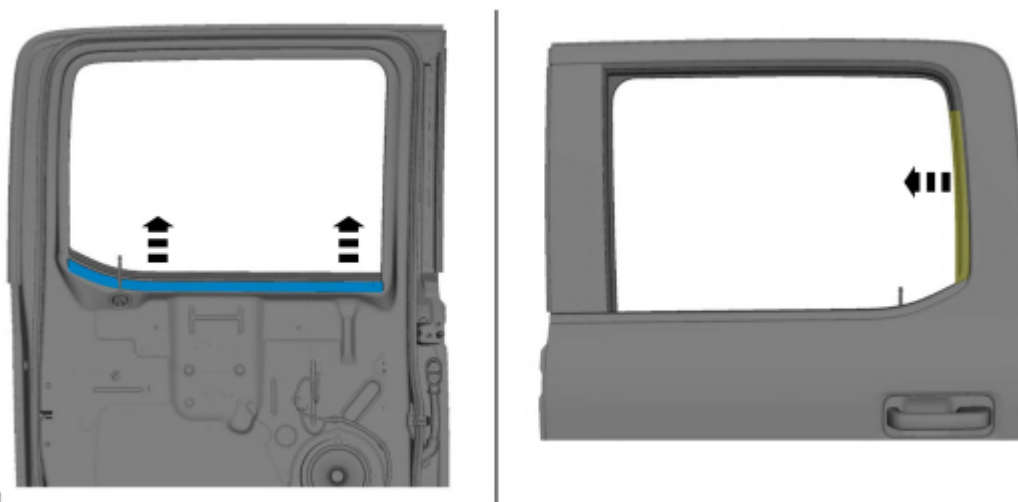

38. If present, remove the foam on the driver and passenger door outer belt moulding at this location. (Figure 30)

Figure 30

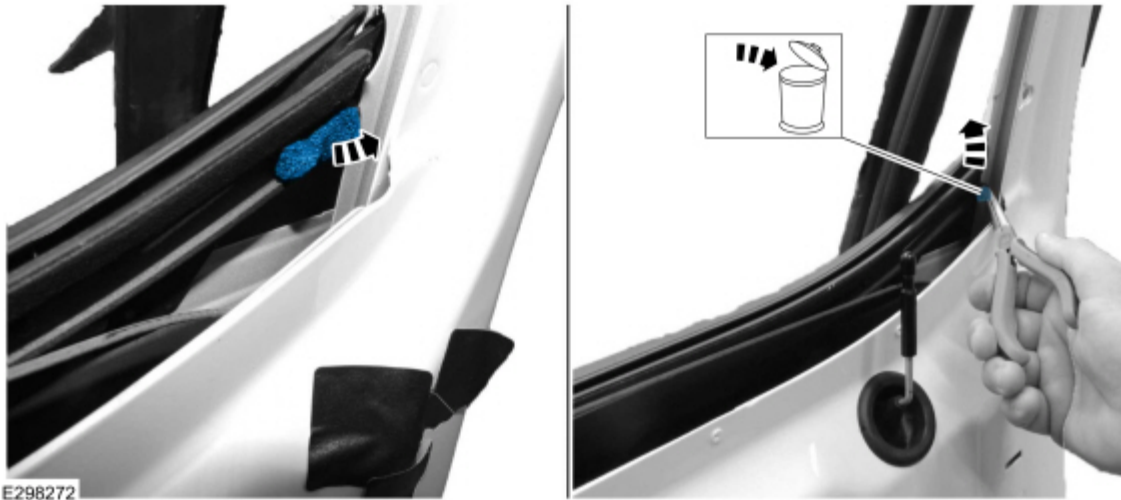

39. Using a clean cloth and isopropyl alcohol, clean the area of the outer belt moulding shown in Figure 31. This is where the foam and silicone will be applied.

Figure 31

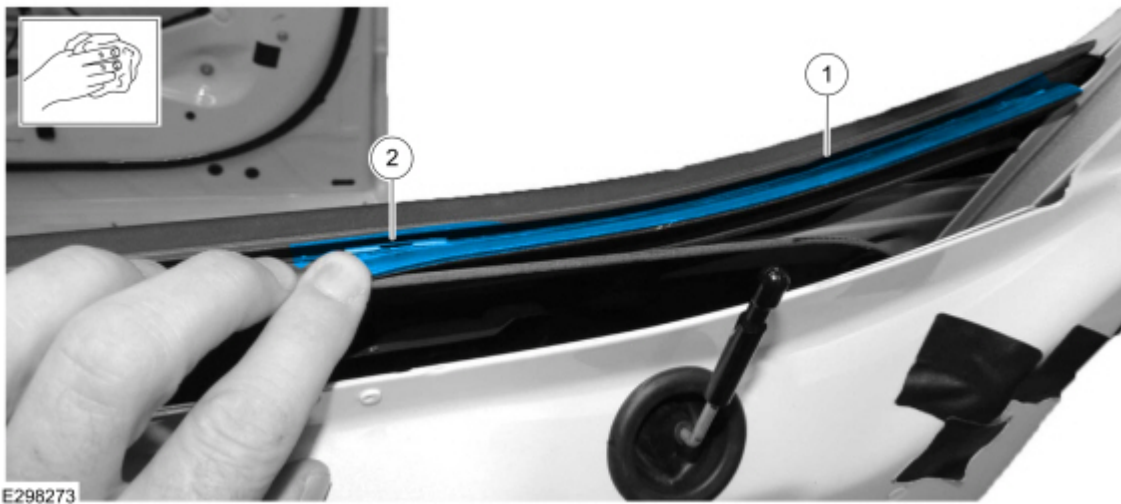

40. Apply Motorcraft® Silicone Sealant to the area on the outer belt moulding shown in Figure 32. Using your finger, smooth out the sealer to establish an even surface. A proper seal around the belt moulding clips shown in Figure 31 is crucial. (Figures 32 - 33)

Figure 32

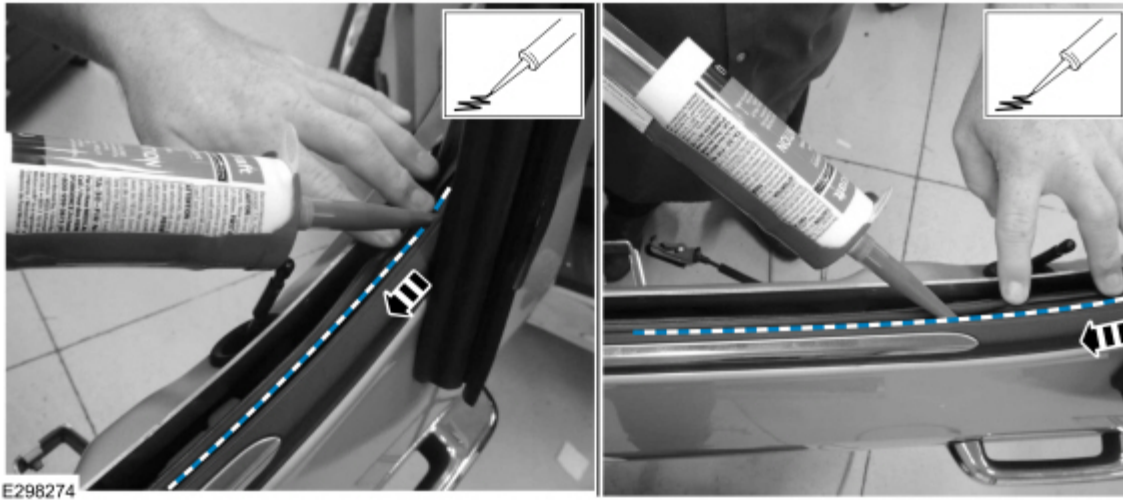
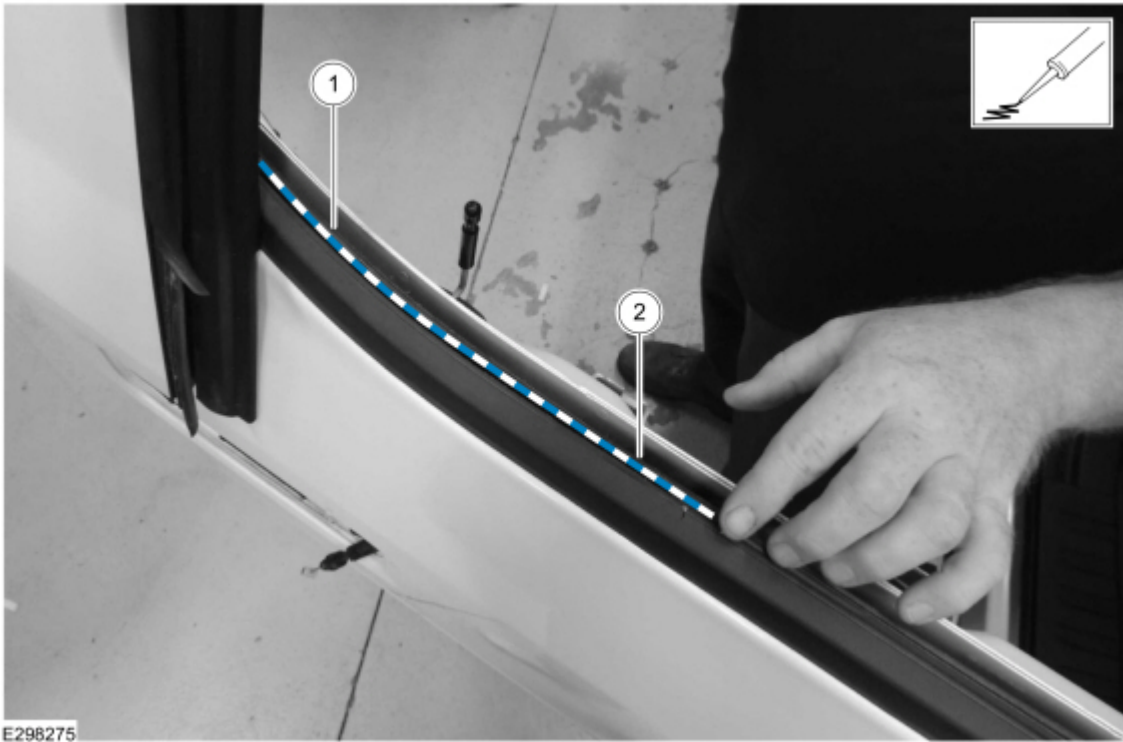
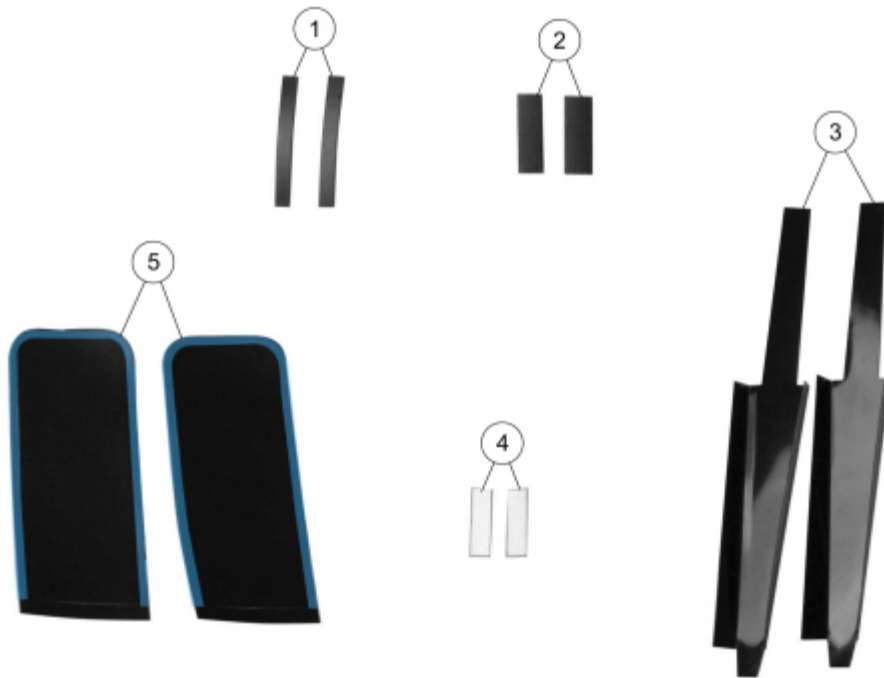

Figure 33



41. Install Foam H (Figure 34 Callout 1) to the C-pillar end of the outer belt moulding as shown in Figure 35. (Figure 34 - 35)

Figure 34



E298276

Item	Description
1	Foam H
2	Foam N
3	Door glass run funnel
4	Foam tape
5	Exterior door handle gasket

Figure 35



E298277

42. On vehicles built on or before 8-Jun-2018, modify the rear door glass top run. (Figure 36)

(1). Measure 15 mm (0.59 in) from the inboard bottom corner of the door glass top run.

(2). Starting at the bottom outboard corner of the front door glass top run, cut a 45 degree notch using the previous measurement as a guide.

Figure 36

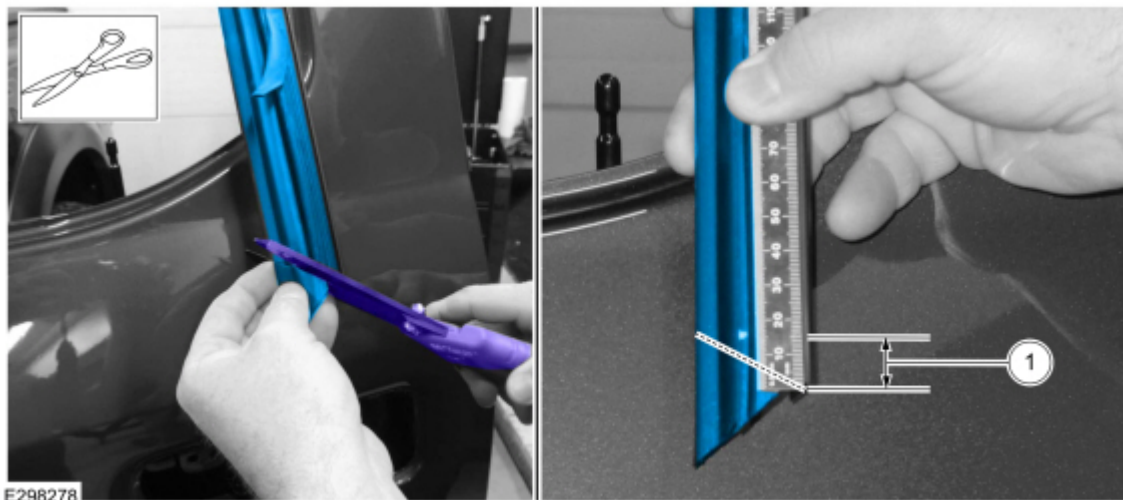

E298278

43. If present, remove the felt on both sides of the rear door glass run. (Figure 37)

Figure 37

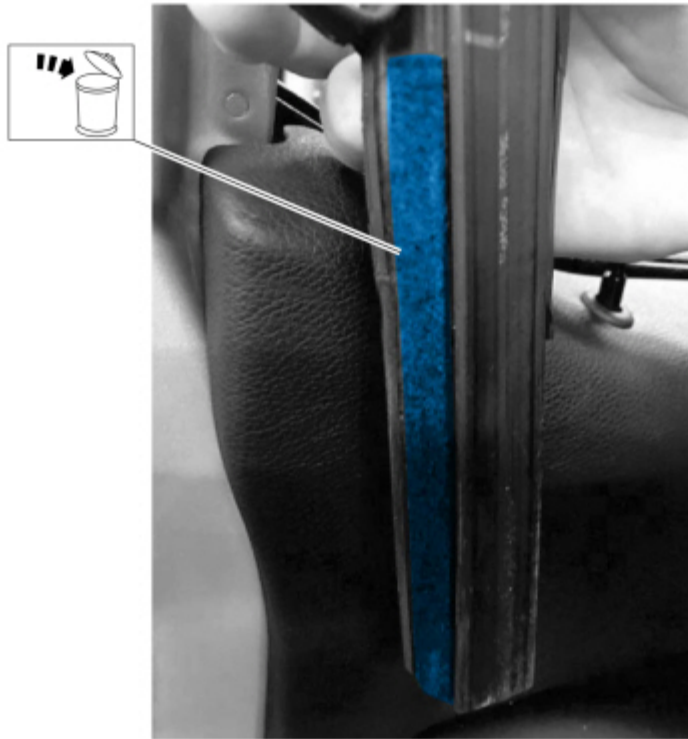

E298279

44. Using a clean cloth and isopropyl alcohol, clean the area of the rear door glass top run as shown in Figure 38.

Figure 38

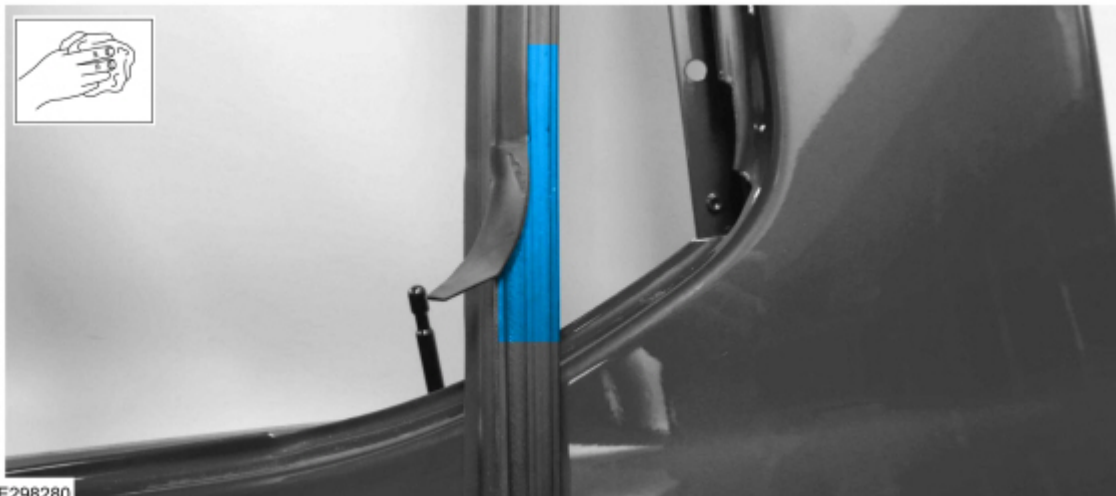

E298280

45. Install Foam N (Figure 34 Callout 2) to the area of the rear door glass top run as shown in Figure 39. Make sure Foam N is under the C-pillar notch shown in Figure 39. Foam H and Foam N must cover the gap shown in Figure 40. (Figure 39 - 40)

Figure 39

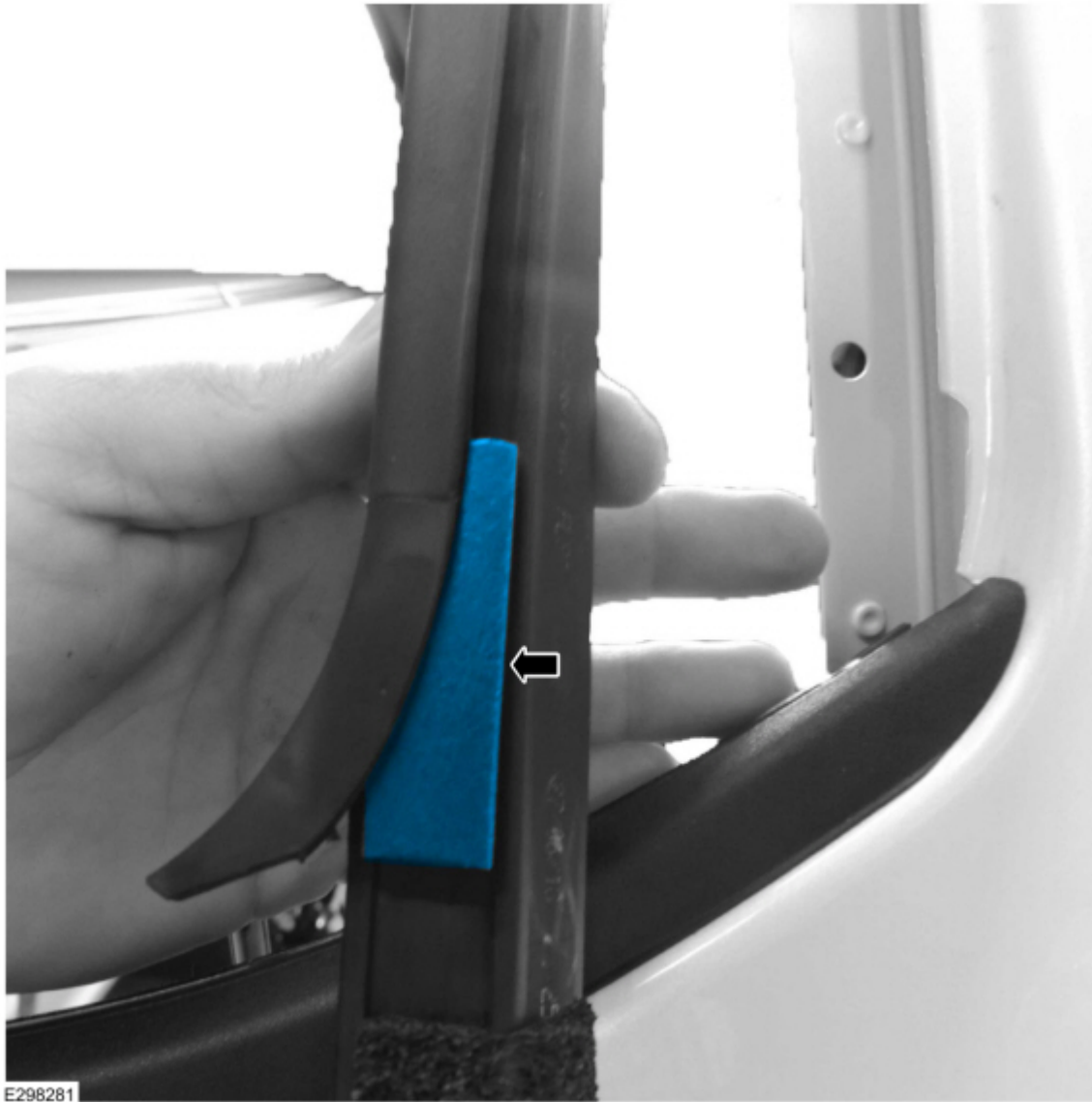
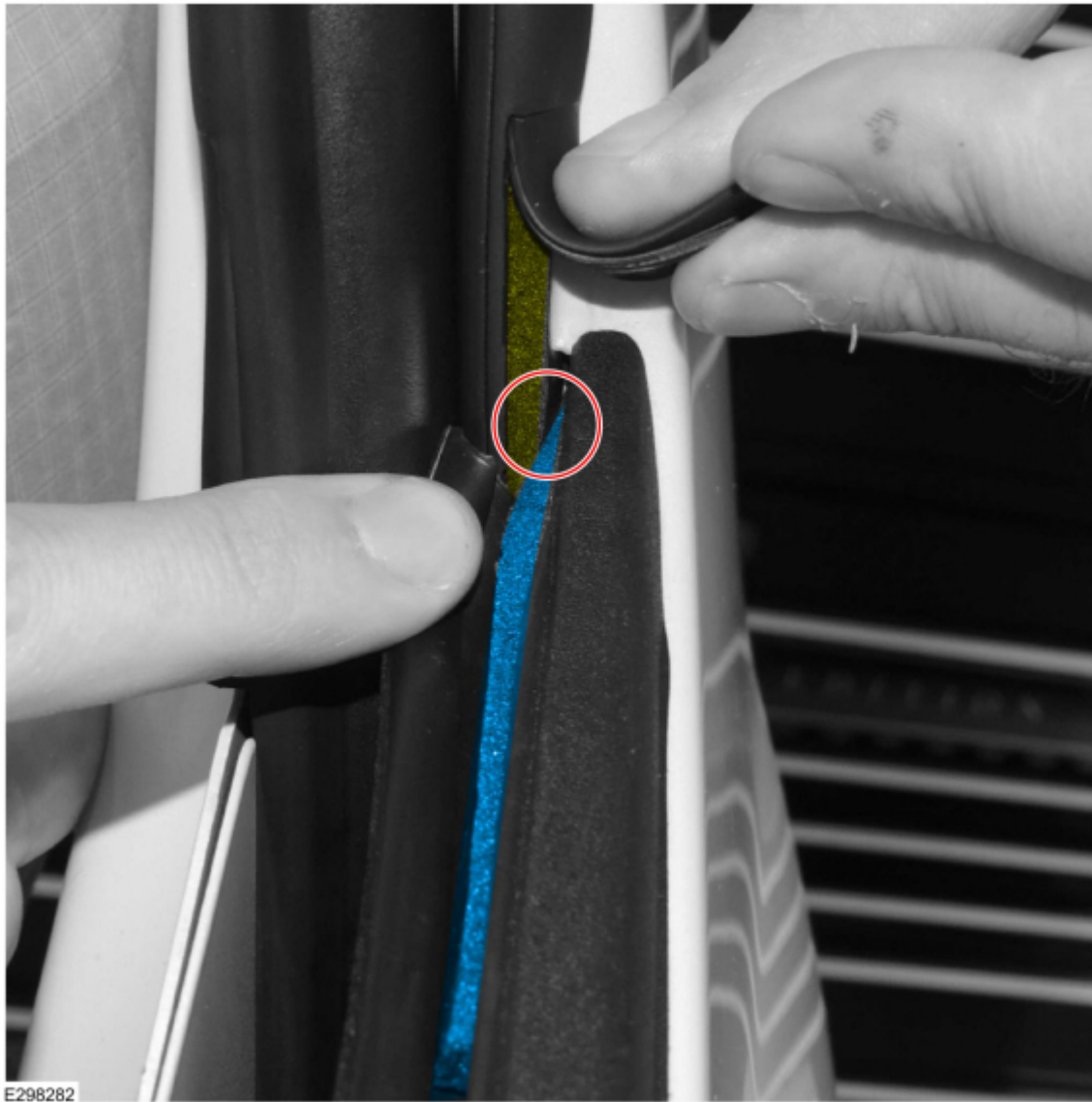

Figure 40



46. With the rear door latch side door glass top run still positioned aside, raise the rear door window glass three quarters of the way up. Use care not to pinch the door glass top run or scratch the glass. (Figure 41)

Figure 41



E298283

- 47.** Apply Motorcraft® Silicone Sealant in and over the joint on the watershield from the front to the outboard corner. Using light finger pressure, smooth the bead of silicone. (Figure 42)

Figure 42

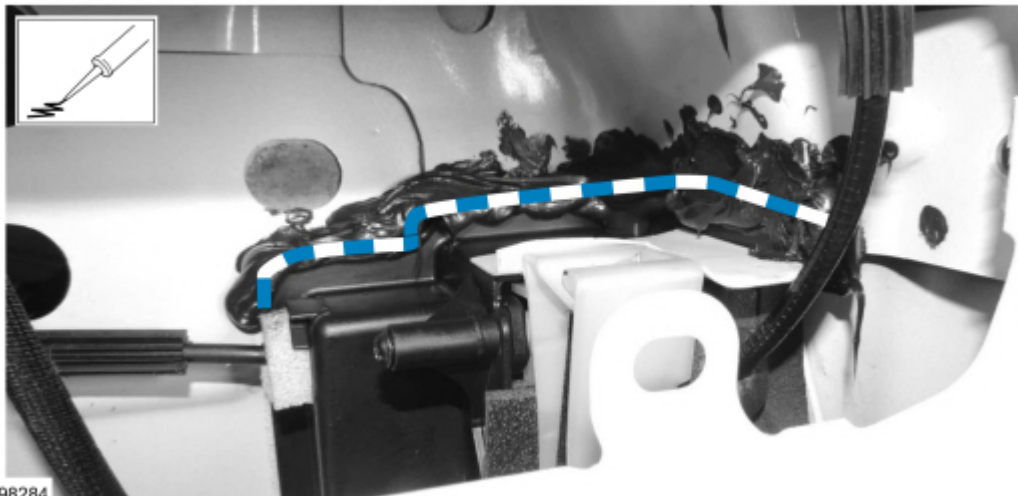

E298284

- 48.** Lower the rear door window glass to the fully down position.
- 49.** Inspect the black plastic funnel received in the parts kit. Refer to Attachment V of FSA 18N03 to verify the correct size funnel was included in the kit. If a door foam kit is found to have the incorrect size door glass run funnels, the correct size door glass run funnels can be removed from another kit. The additional kit the door glass run funnels were removed from can also be claimed with this repair. Discard unused parts from the additional kit.
- (1). Install the black plastic door glass run funnel. (Figure 34 Callout 3) Make sure the lower tab is seated correctly in the door glass run and the funnel legs sit at a 90 degree angle above the door glass run. (Figure 43)

Figure 43

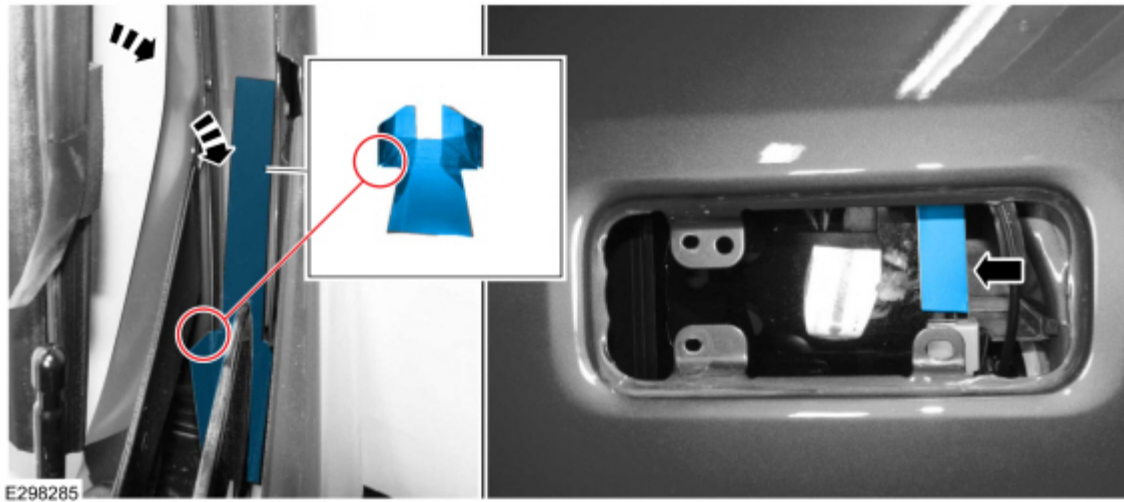

50. Install the rear door glass top run and inner belt moulding. Make sure not to bend or damage the black plastic door glass run funnel. Inspect the position of the funnel through the exterior door handle opening.

51. Raise the rear door glass to the fully up position.

52. Apply the supplied foam tape (Figure 34 Callout 4) to hold the funnel in place in the location shown in Figure 44.

Figure 44

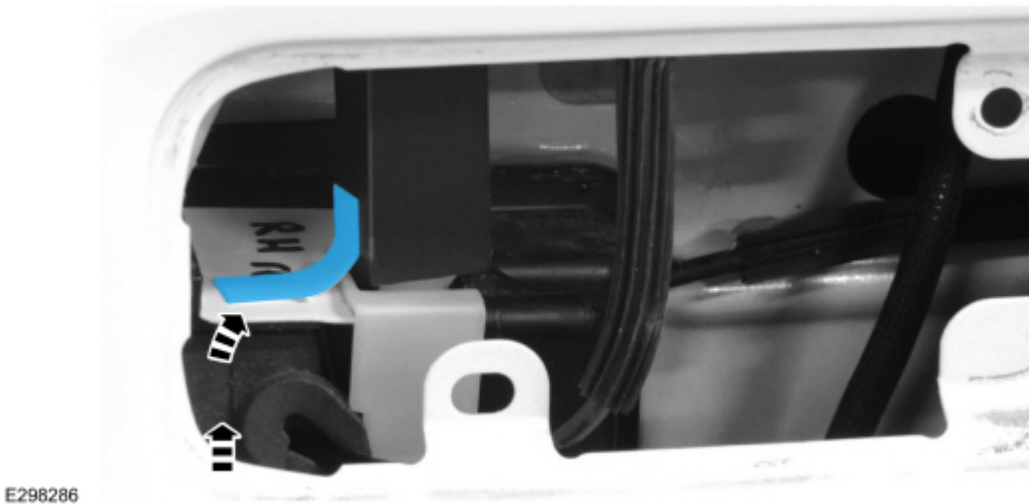

53. Inspect the interior door handle to latch cable for kinking. If necessary, straighten any kinks in the cable by hand. (Figure 45)

Figure 45

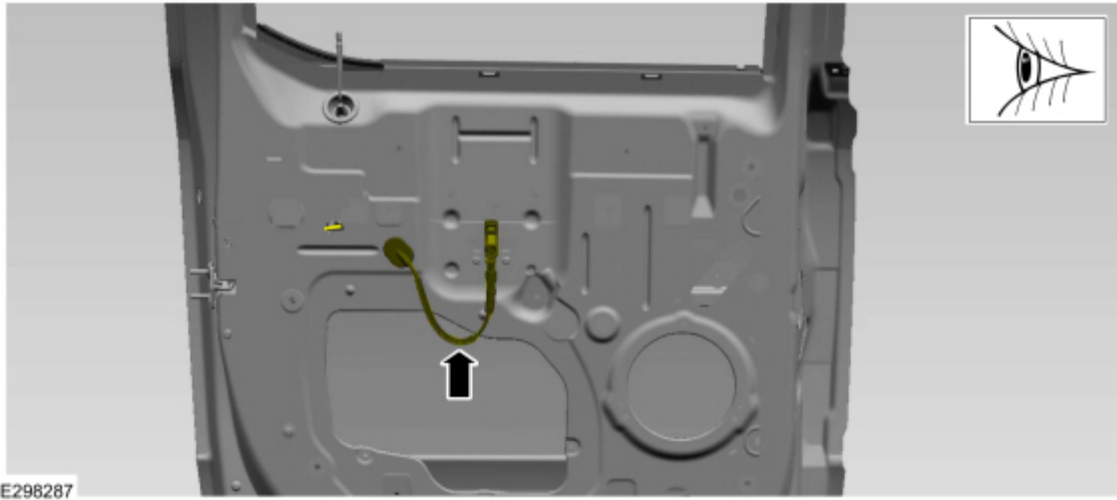

54. Holding the end of the interior door handle cable in the upright position, spray Motorcraft® Silicone Spray for 5 seconds down into the cable. (Figure 46)

Figure 46



55. Using a bungee cord or other suitable device, secure the interior door handle cable to the door in the upright position to allow the lubricant time to run down the cable. (Figure 47)

Figure 47

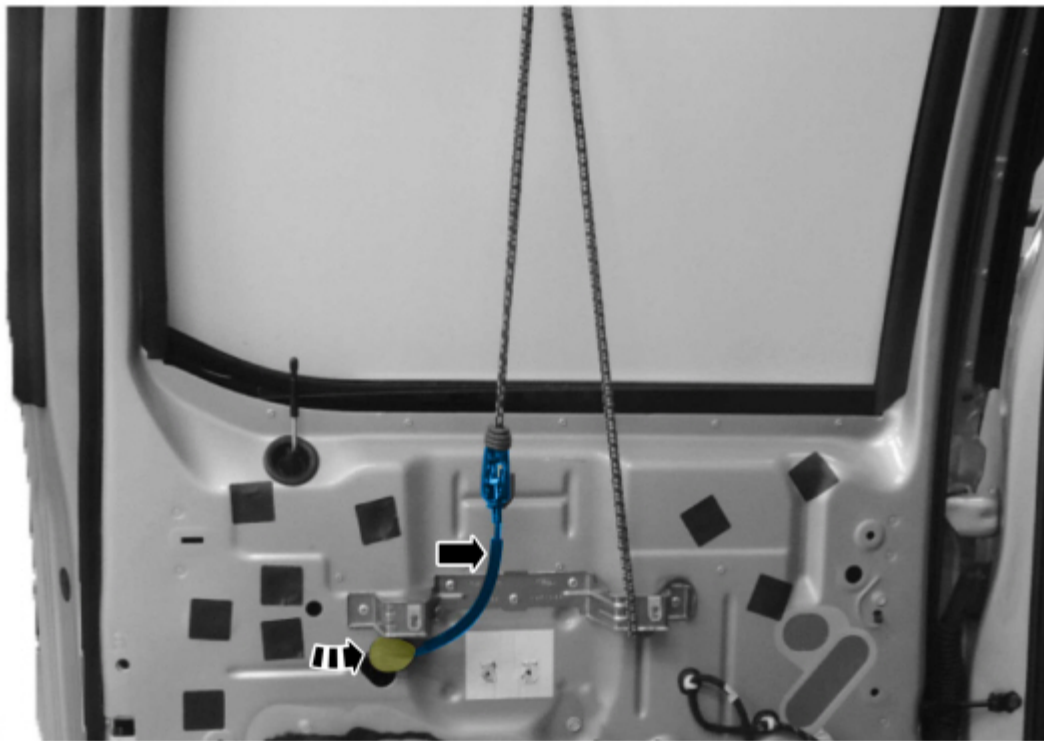

E298289

- 56.** Towel dry the exterior door handle cable to absorb any residual moisture. Using a bungee cord or other similar device, secure the exterior door handle cable to the door in an upward position as shown in Figure 20 to allow the undiluted Motorcraft® Premium Windshield Wash Concentrate or a 99 percent methyl hydrate (methanol) product time to run down into the cable, until the exterior door handle cable is reinstalled later in this procedure.



CAUTION: The use of disposable gloves is required for this step.

- 57.** Place a shop towel around the exterior door handle cable to prevent dripping of the product onto any vehicle surface. Using a syringe, eye dropper, or other suitable applicator draw 10 ml of undiluted Motorcraft® Premium Windshield Wash Concentrate or 99 percent methyl hydrate (methanol) into the applicator. Do not use products containing isopropyl alcohol. With the cable pulled out and the tip of the applicator positioned inside the arrowhead cable end fitting, inject 2 mL between the cable shield and the cable then cycle the cable 5 times in and out of the cable shield. Repeat injecting the fluid and cycling the cable a total of 5 times.
- 58.** Using a clean shop cloth and isopropyl alcohol, clean the mating surface area of the exterior front door handle as shown in Figure 21.
- 59.** Using a clean shop cloth and isopropyl alcohol, clean inside the area shown in Figure 22 on the mating surface area of the front exterior door handle opening.
- 60.** Install a new foam exterior door handle gasket. (Figure 34 Callout 5) Make sure the foam is aligned properly as shown in Figure 24. (Figure 23 - 24)
- 61.** Using a clean shop cloth and isopropyl alcohol, clean the handle plunger then lightly apply Motorcraft® Door Latch Grease to all four sides of the exterior door handle plunger and to the mechanism shown in Figures 25 - 26.
- 62.** Apply a bead of Motorcraft® Silicone Sealant to the latch side area of the front door exterior handle opening metal surface as shown in Figure 28. Make sure the sealant overlaps with the foam on the exterior door handle. (Figure 27)
- 63.** Remove the bungee cord holding the interior door handle cable, seat the rubber grommet and, if equipped, reinstall interior door handle cable retaining clips.

- 64.** Install the exterior front door handles. When connecting the exterior door handle cable to the door handle, lubricate the cable with a thin layer of Motorcraft® Door Latch Grease as shown in Figure 28. Refer to WSM, Section 501-14.
- 65.** Clean any excess silicone around the exterior door handle perimeter using isopropyl alcohol, cotton swabs, and a clean shop cloth to avoid appearance concerns.
- 66.** Repeat Steps 34 through 65 on the other rear door.

© 2019 Ford Motor Company
All rights reserved.

NOTE: The information in Technical Service Bulletins is intended for use by trained, professional technicians with the knowledge, tools, and equipment to do the job properly and safely. It informs these technicians of conditions that may occur on some vehicles, or provides information that could assist in proper vehicle service. The procedures should not be performed by "do-it-yourselfers". Do not assume that a condition described affects your car or truck. Contact a Ford or Lincoln dealership to determine whether the Bulletin applies to your vehicle. Warranty Policy and Extended Service Plan documentation determine Warranty and/or Extended Service Plan coverage unless stated otherwise in the TSB article. The information in this Technical Service Bulletin (TSB) was current at the time of printing. Ford Motor Company reserves the right to supersede this information with updates. The most recent information is available through Ford Motor Company's on-line technical resources.